



Table List Price & Specification Guide

version 19.01



Please Note:

All Commercial-Grade Furniture is Shown with List Pricing

To receive your standard or volume discount, please contact us at info@baltix.com or call us at (952) 698-1220

About Baltix

For more than 20 years, Baltix Sustainable Furniture has been proudly manufacturing durable American Made commercial furniture right here in the heart of Minnesota. Our unwavering commitment to sourcing only the most sustainable and durable raw or finished materials utilized in the fabrication of our products has helped us become a trusted partner to some of the largest companies in the world. This commitment to unparalleled sourcing, engineering, and craftsmanship lends itself to our high-quality finished products that will stand the test of time in all commercial environments. As a socially and environmentally conscious manufacturer, it is our duty to leave as little of a footprint as possible. To help reduce this footprint, we have made a commitment to plant one tree for every product that is ordered and manufactured. We call this our **Buy One. Grow One™** promise. To learn more about how your purchase makes a difference, please turn the page!

Radically Transparent

At Baltix, we believe that transparency builds trust, and we would not have it any other way. Over the years, there has been a significant amount of “green washing” regarding what is truly green, sustainable or not. We are straightforward and honest with our customers by openly sharing technical information about our products and the raw materials that they are made from. If you have questions, we have answers. **We don’t hide behind our tables, we meet at them.**

Customer Centric

Our customers are an integral part of what we do. Without them, we simply would not exist. From first call to final installation and everything in between, our team is committed to providing superior customer service while sharing our vast industry knowledge to guide the specification and ordering process. By choosing Baltix as your furniture partner you can trust that we will manufacture our products to your exacting specification and deliver on-time, every time.

SMaRT® Certified

In 2015, Baltix became the first commercial furniture manufacturer to achieve the Platinum Sustainable Procurement Certification for healthy products. Through our forward-thinking supplier network, we were able to exceed the stringent sustainability certification prerequisites set forth by The Institute for Market Transformation to Sustainability.

American Sourced | American Made

We are proud that our products are manufactured here in Minnesota. By strategically partnering with our U.S. based raw and finished material supplier network, we can produce our products with precision quality, shorter lead times, and unbeatable value, while also contributing to the creation of American jobs.





ONETREEPLANTED

At Baltix, we are a company set on the foundation of environmental preservation. We are here not only to help your purchases make a difference, but to also help reduce the footprint that our company and our products leave behind. Baltix is proud to have partnered with OneTreePlanted.org, a 501(c)(3) non-profit that helps restore our forests by replanting trees in deforested areas across the world. In creating our Baltix One Tree Planted partnership, we are taking our environmental leadership one step further; we call this our **Buy One. Grow One™** promise. For every product ordered and manufactured, we have committed to planting one tree in an effort to improve the global environment we share and live in.

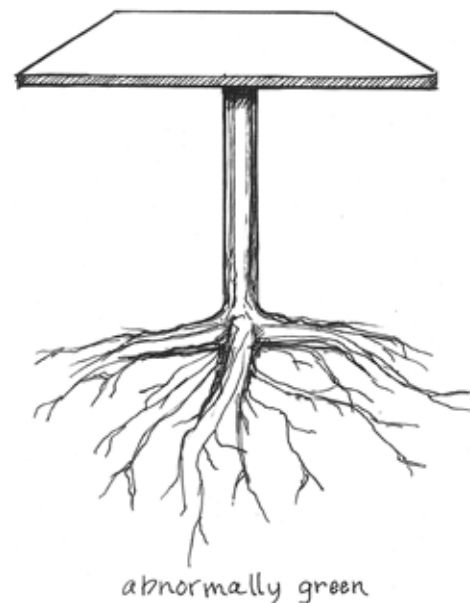

Contents

04Sustainable Surface Materials

06	(F2) Wilsonart® Standard Laminate with Matching Edgeband
07	(F4) Wilsonart® Standard Laminate on Birch Multiply
08	(F6) Forbo® Linoleum with BioEdge™ Edgeband
09	(F7) Forbo® Linoleum on Birch Multiply
10	(F8) Powder Coated MDF
11	(F16) Nuxite®
12	(F17) Solid Hardwood (Butcher Block)
13	(F18) Cambria® Quartz
14	(F19) Corian® Quartz
15	(F20) Caesarstone® Quartz
16	(F21) Consentino® Silestone® Quartz
17	(F22) Consentino® DEKTON® Ultracompact Surface
18	(F23) Corian® Solid Surface
19	(F24) Livingstone® Solid Surface

20Sustainable Base Materials & Finishes

22	Steel Bases
23	Cast Iron Bases
23	Stainless Steel Bases

24Hospitality & Multi-use Tables

26..... Hospitality & Multi-use Base Styles

28	Mode Base Tables (BM)
30	Taper Base Tables (BE)
32	Zone Base Tables (BZ)
34	Toob Base Tables (BT)
36	Double Column Flip-Top Toob Base Tables (BTF)
38	Wedge Base Tables (BW)
40	Ingot Base Tables (BI)
42	Arch Base Tables (BA)
44	Double Column Flip-Top Arch Base Tables (BAF)
46	Swoop Base Tables (BS)
48	Bold Base Tables (BB)
50	Slim Round Base Tables (BSD)
52	Slim Square Base Tables (BSS)
54	Slim Squircle Base Tables (BSQ)
56	Stainless Steel Square Base Tables (BST)
58	Floor Mounted Base Tables (BFM)
60	Heavy Round Base Tables (BHR)
62	Trumpet Base Tables (BR)
64	Picture Frame Base Tables (BPF)
66	Angled Base Tables (BAC)
68	Ornate Base Tables (BO)
69	Cantilevered Base Tables (BC)

70Collaboration Tables

72..... Collaboration Base Styles

73	A-Frame Base Tables (BAFC)
74	Picture Frame Base Tables (BPFC)
75	Parsons Base Tables (BPRC)
76	H-Frame Base Tables (BHC)

78Occasional Tables

80..... Occasional Base Styles

81	Cubic Base Tables (BCU)
82	C-Base Tables (BCE)
83	Laptop Base Tables (BLT)
84	Picture Frame Base Tables (BPFCO)

86Conference Tables

88..... Conference Table Base Styles

89	Toob Base Tables (BTT)
90	Ingot Base Tables (BII)
91	Arch Base Tables (BAA)
92	XL Angled Base Tables (BAX)
93	Drum Base Tables (BDR)
94	Mono Base Tables (BF)

96Greenlites™ Lightweight Tables

100...Adjustable Height Tables

104...Lecterns

108...Filing & Storage Units

112...Optional Power/Data Unit Add-ons

114...Optional Wire Management Add-ons

116...Table Top Only (TT)

118...Terms & Conditions of Sale

119...Warranty, Limitations, & Disclaimers

Sustainable Surface Materials



(F2) Wilsonart® Standard Laminate with Matching Edgeband

Wilsonart® laminate surfaces offer designers a range of options from dramatic and playful to natural and subdued designs. The majority of Wilsonart® laminate finishes feature AEON™ Enhanced Performance Technology. AEON™ Technology outperforms traditional laminates on wear resistance, as well as scratch/scuff/mar resistance by up to 5 times. Wilsonart® laminate is 70% paper, making it the most environmentally friendly laminate option on the market. With continuous product and process improvement, Wilsonart® laminate has a minimal impact on the environment. At Baltix we use a non-VOC adhesive to adhere Wilsonart® laminate surfaces to a 100% recycled, CARB II compliant particle board substrate finished with a 3mm matching Wilsonart® edgeband for a seamless look and finish.

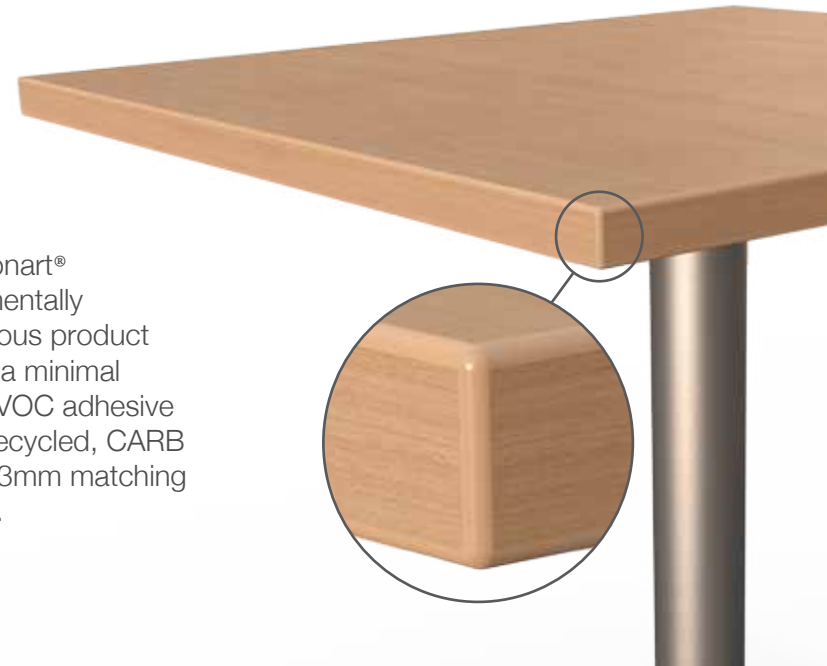

(F4) Wilsonart® Standard Laminate on Birch Multiply

Wilsonart® laminate surfaces offer designers a range of options from dramatic and playful to natural and subdued designs. The majority of Wilsonart® laminate finishes feature AEON™ Enhanced Performance Technology. AEON™ Technology outperforms traditional laminates on wear resistance, as well as scratch/scuff/mar resistance by up to 5 times. Wilsonart® laminate is 70% paper, making it the most environmentally friendly laminate option on the market. With continuous product and process improvement, Wilsonart® laminate has a minimal impact on the environment. At Baltix we use a non-VOC adhesive to adhere Wilsonart® laminate surfaces to a CARB II compliant birch multiply substrate. The exposed edges of the birch multiply substrate are then finished with a non-VOC clearcoat to provide protection from moisture and heavy commercial use.



Wilsonart Laminate Design Sampling

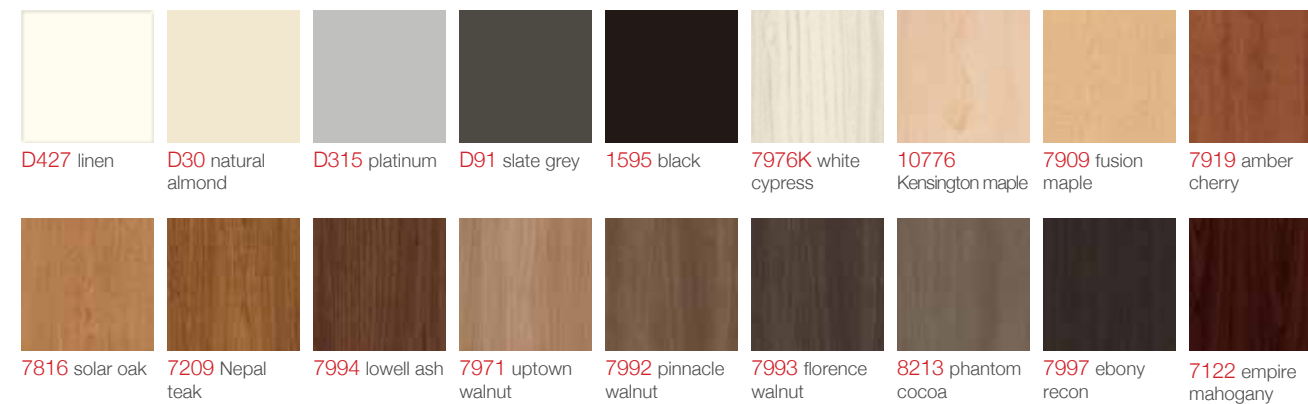

Please Note: Baltix standard Wilsonart laminate finishes are 38 or 60. Non-standard Wilsonart finishes require an upcharge. Hundreds of additional laminate colors and designs are available. Baltix also works with laminates from Formica, Nevimar, and Pionite.

Edge Profile

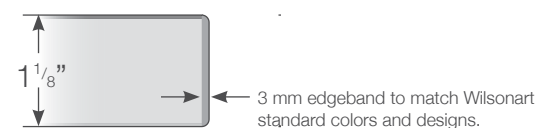

Corner radius: 3/32"

Wilsonart Laminate Design Sampling



Please Note: Baltix standard Wilsonart laminate finishes are 38 or 60. Non-standard Wilsonart finishes require an upcharge. Hundreds of additional laminate colors and designs are available. Baltix also works with laminates from Formica, Nevimar, and Pionite.

Edge Profile Options



Corner radius: 3/4"

Corner radius: 1/8"

(F6) Forbo® Linoleum with BioEdge™ Edgeband

Forbo® Marmoleum™ (linoleum) is a versatile classic with a contemporary edge. Ranging from subtle marbled designs to modern concrete and intriguing striated patterns, Forbo® Marmoleum™ offers a design to suit every taste or application. Finished with Topshield 2™, Forbo® Marmoleum™ can stand the test of time in all commercial applications. Naturally beautiful, durable, sustainable and healthy! Marmoleum™ is a 100% USDA Certified Biobased Product. Marmoleum™ is made from 97% natural raw materials, 70% of which are rapidly renewable, along with 43% recycled content. The key raw materials include linseed oil, wood flour, jute, and pine rosin. At Baltix we use a non-VOC adhesive to adhere Forbo® Marmoleum™ to a CARB II compliant 100% recycled particle board substrate. The edges are finished with a non-PVC BioEdge™ edgeband, a bio-plastic material made from corn biopolymer.



(F7) Forbo® Linoleum on Birch Multiply

Forbo® Marmoleum™ (linoleum) is a versatile classic with a contemporary edge. Ranging from subtle marbled designs to modern concrete and intriguing striated patterns, Forbo® Marmoleum™ offers a design to suit every taste or application. Finished with Topshield 2™, Forbo® Marmoleum™ can stand the test of time in all commercial applications. Naturally beautiful, durable, sustainable and healthy! Marmoleum™ is a 100% USDA Certified Biobased Product. Marmoleum™ is made from 97% natural raw materials, 70% of which are rapidly renewable, along with 43% recycled content. The key raw materials include linseed oil, wood flour, jute, and pine rosin. Baltix uses a non-VOC adhesive to adhere Forbo® Marmoleum™ to a CARB II compliant birch multiply substrate. The exposed edges of the birch multiply substrate are then finished with a non-VOC clearcoat to provide protection from moisture and heavy commercial use.



Forbo Linoleum Design Sampling

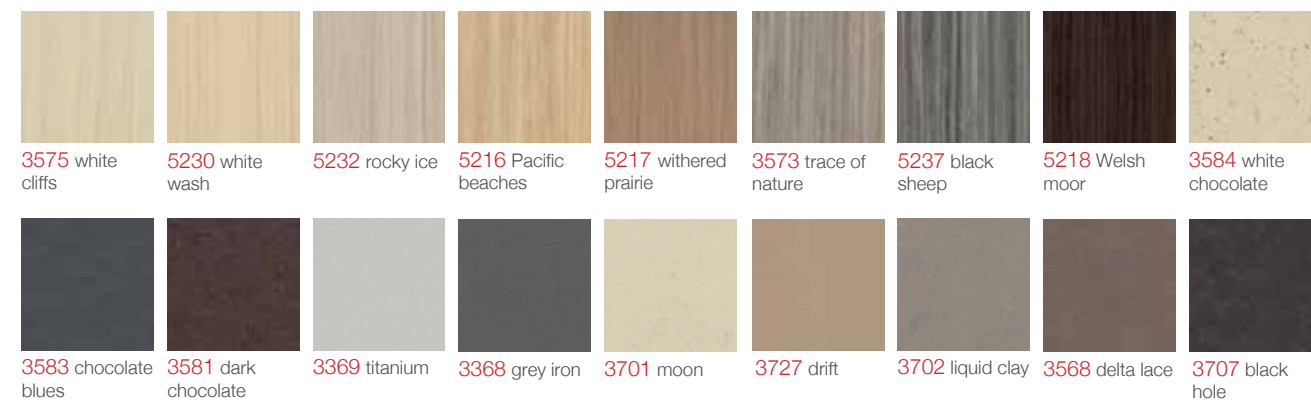

Please Note: Hundreds of additional linoleum colors and designs are available.

Forbo Linoleum Design Sampling



Please Note: Hundreds of additional linoleum colors and designs are available.

Edge Profile & BioEdge™ Edgeband Color Selection



Edge Profile Options

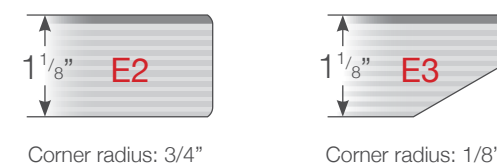

(F8) Powder Coated MDF

Wood (MDF) powder coating is one of the strongest finishes available, making it perfect for a wide variety of tabling applications. Using a revolutionary technology, the cross-link color polymers are thermally fused to a CARB II compliant MDF substrate. Unlike edge-banded tables, powder coated wood offers seamless edges that will not accumulate harmful bacteria and dirt. The powder coating process and finish is environmentally friendly, with no HAP's, VOC's, PVC's, or hazardous wastes. The overspray from powder coating is also reused, not wasted. This unique process results in an exceptionally strong bond for a smooth finish that is moisture and stain resistant and durable for a long useful life.



52.698.1220

(F5) Nuxite®

Nuxite® is a biocomposite surface material unmatched in its combination of beauty, warmth, and durability. It is a naturally stain-resistant and renewable material unlike any other. This biocomposite material is made from crushed walnut shells suspended in a zero VOC resin binder. This resin binder does not off-gas any harmful chemical byproducts before, during, or after the creation of each surface. In addition, this premium resin allows us to make a table surface that is stronger, more durable, and more environmentally friendly than composites made with polyester resin. The walnut shells are sustainably grown and are a renewable byproduct of the annual walnut food crop harvest.



Powder Coat Color Sampling



137 white 133 Swiss coffee 143 dove 146 grey 144 chocolate

Nuxite Close-up



Please Note: Custom colors are available; minimum quantity and set-up fees will apply.

Edge Profile Options

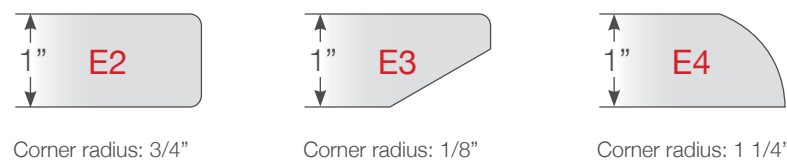

Corner radius: 3/4" Corner radius: 1/8" Corner radius: 1 1/4"

Edge Profile

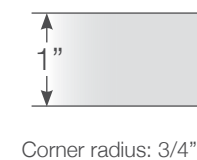

Corner radius: 3/4"

(F17) Solid Hardwood (Butcher Block)

Our solid hardwood butcher block surfaces are created with superior high quality craftsmanship and constructed with kiln-dried, uniform-width staves face-glued in a continuous pattern. We offer a number of beautiful hardwood species including maple, oak, ash, beech and walnut. Each hardwood surface is finished with food-safe and moisture-resistant clearcoat finish. With no additional upcharge, we also offer walnut stain finish for maple, oak, ash, and beech species. Following multiple years of use, this hardwood material can be sanded and refinished for extended life of the table surface.



(F18) Cambria® Quartz

Cambria® quartz is 93% pure, natural quartz, one of the hardest and most abundant minerals on Earth. Created with American-made quality, Cambria offers easy-care convenience, 100% non-absorbency, and incredible durability for even the busiest commercial settings. Cambria's commitment to the environment includes the recycling of all metal tooling, as well as 100% of the water used in polishing. Cambria® is a member of the Health Product Declaration Collaborative (HPDC), Living Building Challenge Compliant, and is a participating member in the Declare program. In addition, Cambria has been certified by Mindful Materials. Each table surface includes a 3/4" plywood insert for easy base attachment.



Hardwood Species Selection

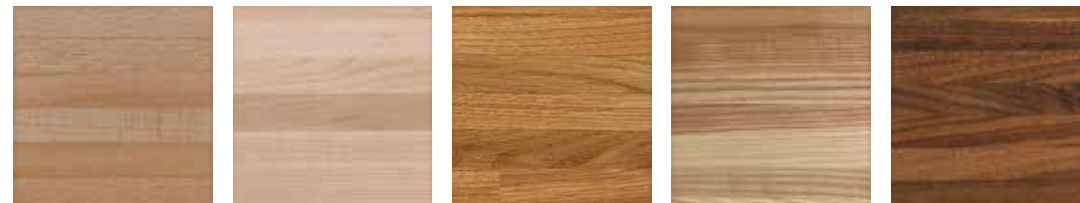

B beech **M** maple **O** oak **A** ash **W** walnut*



BW beech with walnut stain **MW** maple with walnut stain **OW** oak with walnut stain **AW** ash with walnut stain

Please Note: Add a 25% upcharge to list price for walnut species. Custom stains available; set up fees will apply. It is the customer/user's responsibility to maintain a 30% humidity level to accommodate solid wood tables.

Edge Profile Options

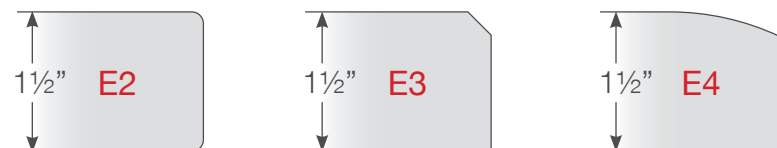

Corner radius: 3/4" Corner radius: 3/4" Corner radius: 1/8"

Cambria Design Sampling

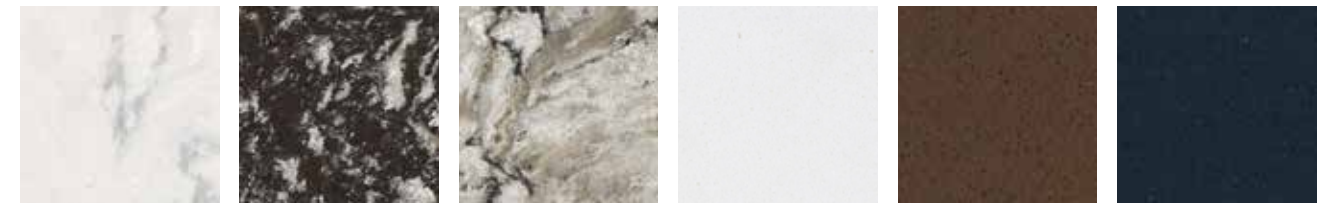

SW Swanbridge™ **BR** Braemar™ **BE** Bellingham™ **WL** Whitehall™ **CB** Cherrybrook™ **HA** Hadley™

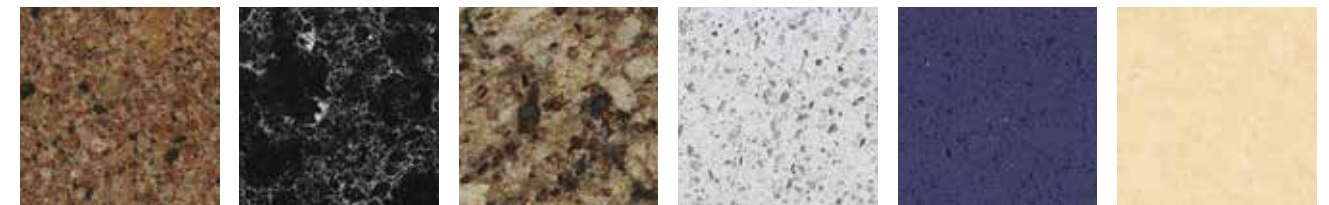

CH Chatham™ **SH** Sharpham™ **CA** Canterbury™ **WY** Whitney™ **BB** Bala Blue™ **FA** Fairbourne™

Please Note: Hundreds of additional Cambria designs are available. Luxury style and matte finish available; contract Baltix for pricing. Standard thickness is 3cm (1-3/16"); contact Baltix for pricing on 2cm and 4cm thicknesses. Tables include a predrilled 3/4" plywood insert for easy base attachment.

Edge Profile Options



Corner radius: 3/4" Corner radius: 3/4" Corner radius: 3/4" Corner radius: 1"

(F19) Corian® Quartz

Corian® quartz (formerly Zodiaq® Quartz) is engineered with pure quartz crystals making it an extremely durable table surface that can withstand the daily wear and tear of commercial environments. This added durability minimizes the short and long-term maintenance regimens that other surface materials require. In addition, Corian® quartz contributes to sustainable design. Corian® quartz and its adhesives and sealants meet or exceed emissions guidelines for volatile organic compounds (VOC's), and are nontoxic and non-allergenic for humans. Each table surface includes a 3/4" plywood insert for easy base attachment.

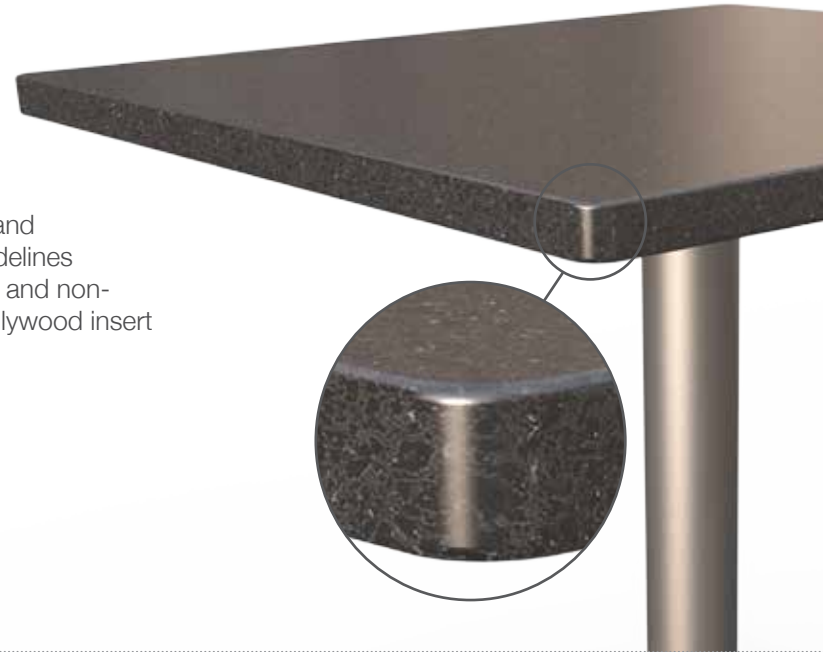

(F20) Caesarstone® Quartz

Caesarstone® quartz surfaces combine beauty with outstanding performance, enabling you to bring your design imagination to life. Caesarstone® surfaces meet exacting standards of excellence from initial procurement of raw materials to the final quality control check. Caesarstone® quartz is blended at a ratio of up to 93% natural quartz aggregates with pigments and polymer resins. Caesarstone® quartz meets the exacting American GREENGUARD Standards and is a member of the Healthy Product Declaration (HPD) for material transparency. Each table surface includes a 3/4" plywood insert for easy base attachment.

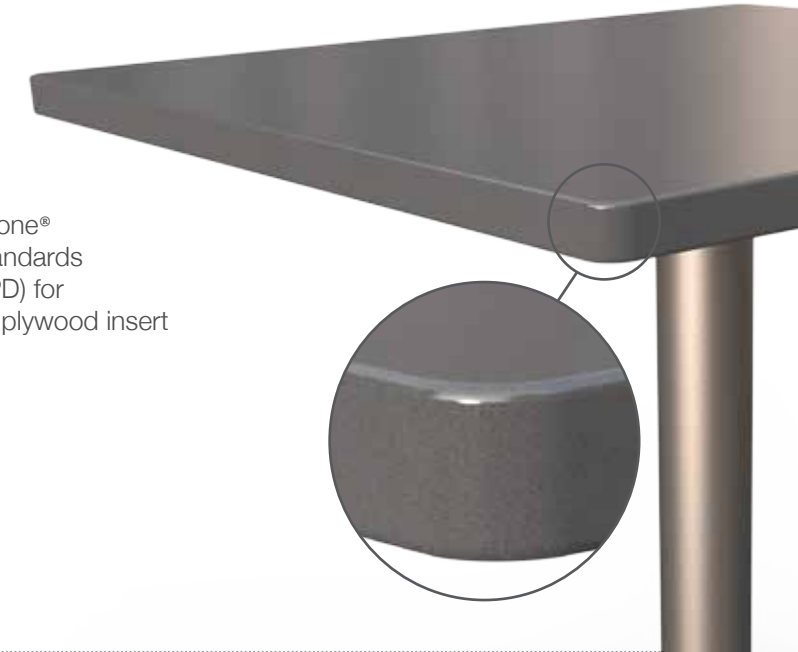

Corian Quartz Design Sampling

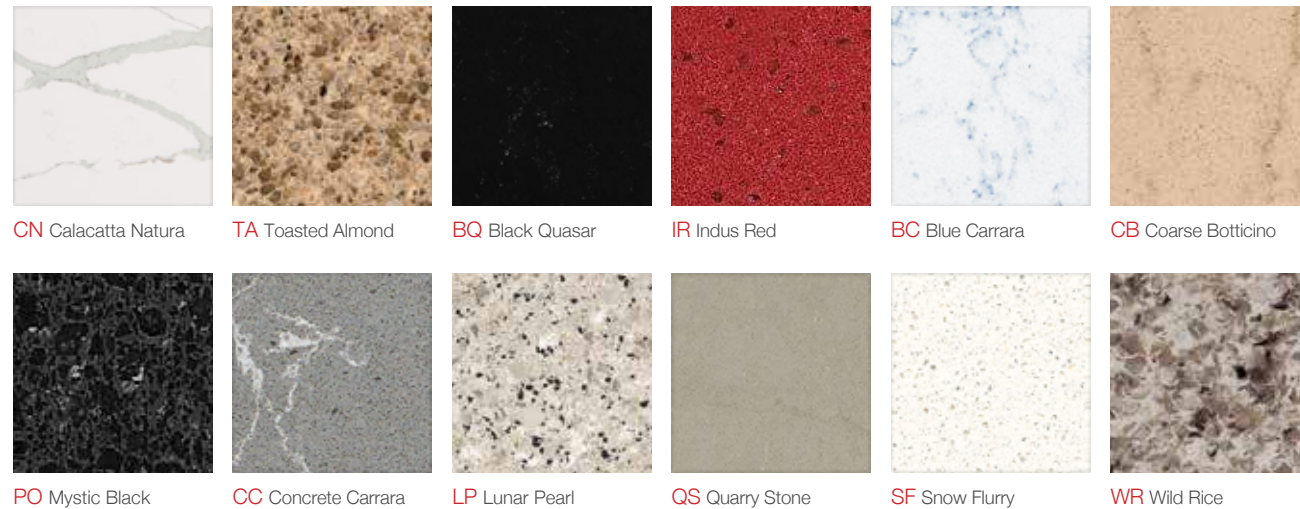

Please Note: 56+ design options available. Tables include a predrilled 3/4" plywood insert for easy base attachment. Due to the yielding of this material, Corian Quartz tables are quote only. Please contact Baltix for pricing.

Caesarstone Design Sampling

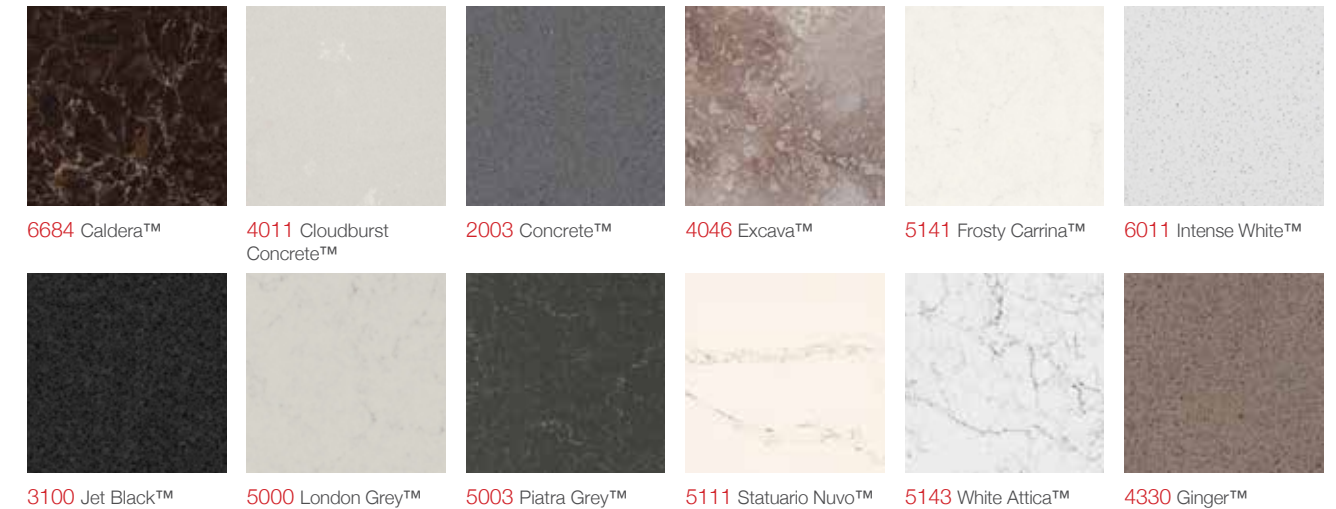

Please Note: 50+ design options available. Tables include a predrilled 3/4" plywood insert for easy base attachment. Due to the yielding of this material, Caesarstone Quartz tables are quote only. Please contact Baltix for pricing.

Edge Profile Options

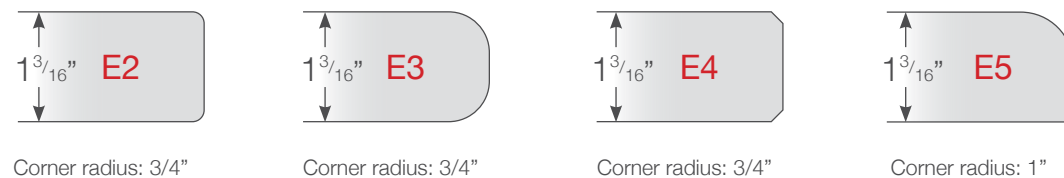

Edge Profile Options

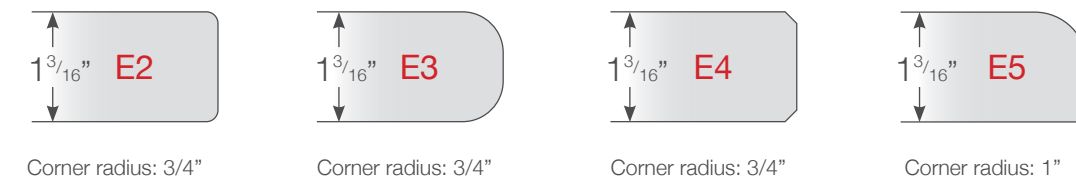

(F21) Consentino® Silestone® Quartz

Silestone® natural quartz is a surface material with outstanding properties created for almost any commercial application. Silestone® is low-maintenance and has a low absorption rate. Silestone's nearly indestructible surface is stain, scorch, and scratch-resistant. In addition to its durability, this material is offered in wide variety of beautiful color options that are sure to catch your eye. Silestone® is internationally certified to ensure maximum safety and protection. Each table surface includes a 3/4" plywood insert for easy base attachment.

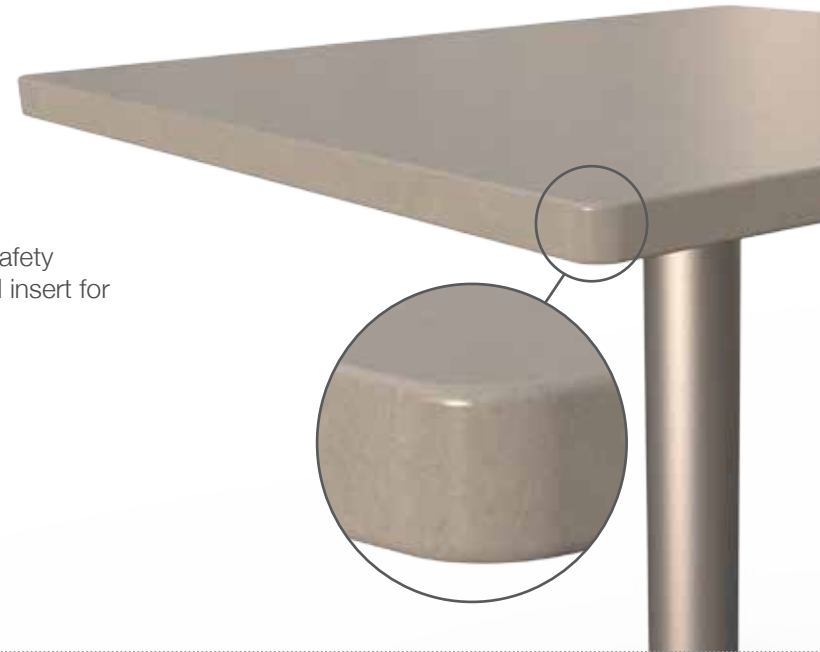

(F22) Consentino® DEKTON® Ultracompact Surface

DEKTON® Ultracompact Surface is a sophisticated blend of the raw materials used to produce the very latest in glass and porcelain as well as the highest quality quartz surfaces. DEKTON® employs exclusive Sinterized Particle Technology, a high-tech process which represents an accelerated version of the metamorphic change that natural stone undergoes when subjected to high temperatures and pressure over thousands of years. DEKTON® offers zero porosity and a lack of micro-defects that cause tension and weak spots. This cutting-edge material offers superior scratch resistance, stain resistance, and resistance to temperature variation. In addition, DEKTON® is highly resistant to ultra violet (UV) light allowing this material to be utilized for indoor and outdoor applications. DEKTON® is GREENGAURD certified GOLD and has obtained the Environmental Product Declaration (EPD). Each table surface includes a 3/4" plywood insert for easy base attachment.



Consentino Silestone Design Sampling

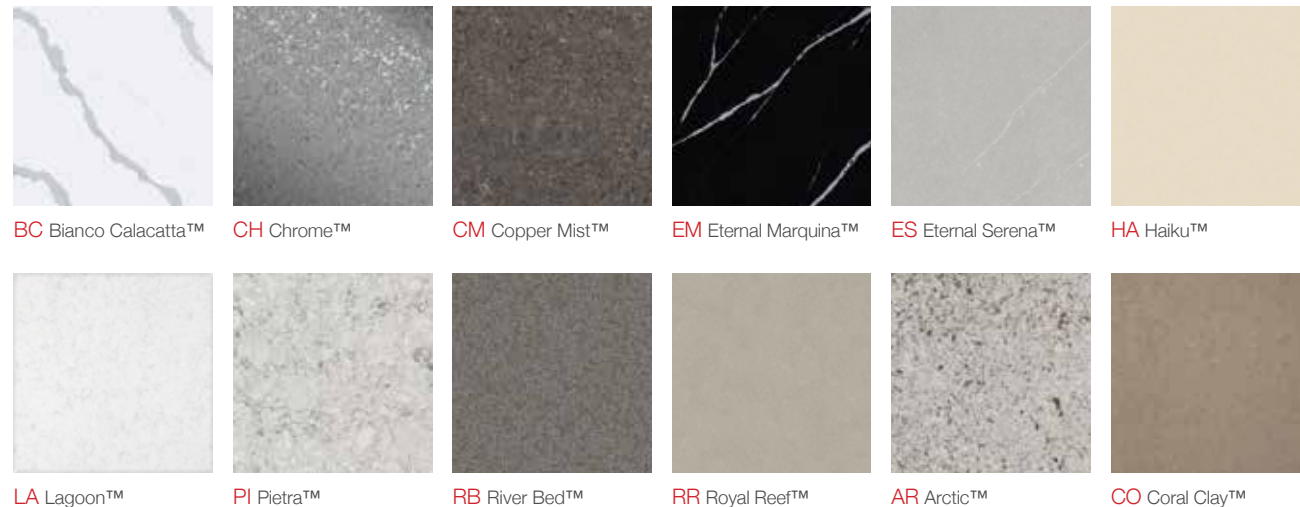

Please Note: 60+ design options available. Tables include a predrilled 3/4" plywood insert for easy base attachment. Due to the yielding of this material, Silestone Quartz tables are quote only. Please contact Baltix for pricing.

Consentino Dekton Design Sampling

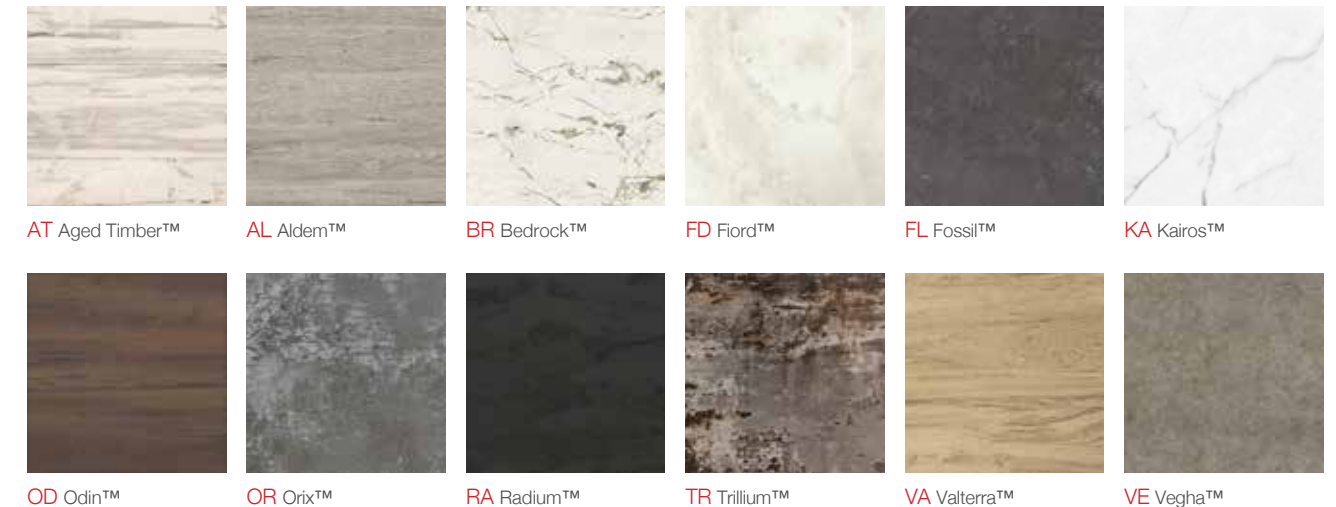

Please Note: 50+ design options available. Tables include a predrilled 3/4" plywood insert for easy base attachment. Due to the yielding of this material, DEKTON tables are quote only. Please contact Baltix for pricing.

Edge Profile Options

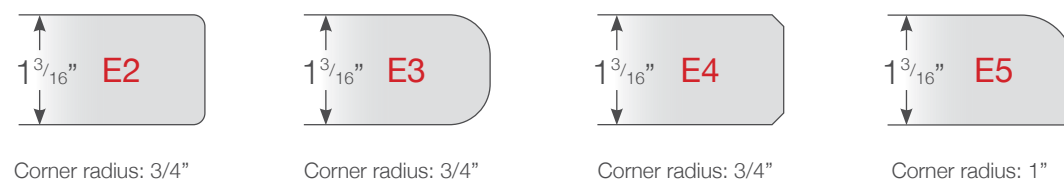

Edge Profile Options



(F23) Corian® Solid Surface

Corian® solid surface is a solid nonporous homogenous surface material, composed of 1/3 acrylic resin and 2/3 natural minerals. Corian® solid surface offers designers versatility, functionality and durability across many commercial applications. It has low moisture absorption, and is resistant to environmental pollutants, humidity, and freeze-thaw conditions. With these unique material characteristics, Corian® solid surface can be utilized for indoor and outdoor applications. Corian® solid surfaces and cured Corian® adhesives and sealants are GREENGUARD Indoor Air Quality Certified® for low VOC content emissions. In addition, Corian® solid surface is nontoxic and non-allergenic to humans. Each table surface includes a 3/4" plywood insert for easy base attachment.

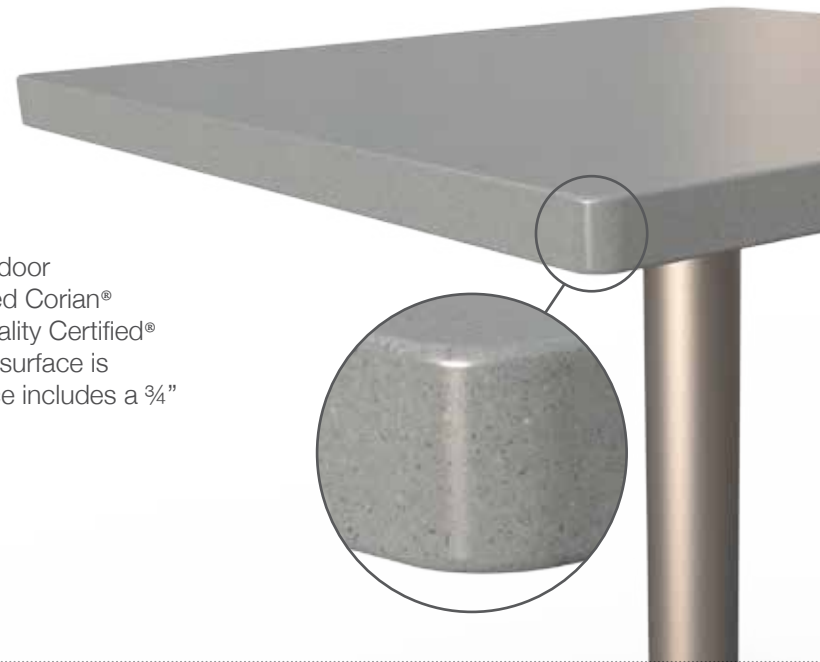

(F24) Livingstone® Solid Surface

LivingStone® 100% acrylic solid surface is a non-porous, homogenous material comprised of acrylic polymers and natural minerals yielding a through-body color, not laminated, coated, or of composite construction. In its finished form, LivingStone® solid surface is nontoxic, and non-allergenic to humans and can be utilized for indoor and outdoor use. LivingStone® solid surface is easy to clean and maintain allowing for years of legendary performance. LivingStone® is sure to have a color or design to meet your requirements. Each table surface includes a 3/4" plywood insert for easy base attachment.



Corian Solid Surface Design Sampling

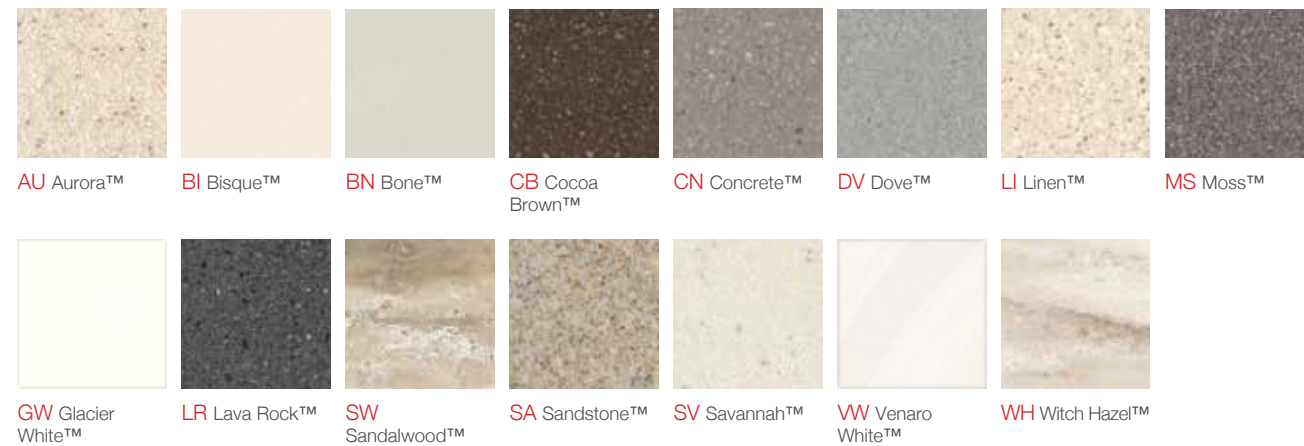

Please Note: 110+ design options available. Tables include a predrilled 3/4" plywood insert for easy base attachment. Due to the yielding of this material, Corian Solid Surface tables are quote only. Please contact Baltix for pricing.

Livingstone Design Sampling

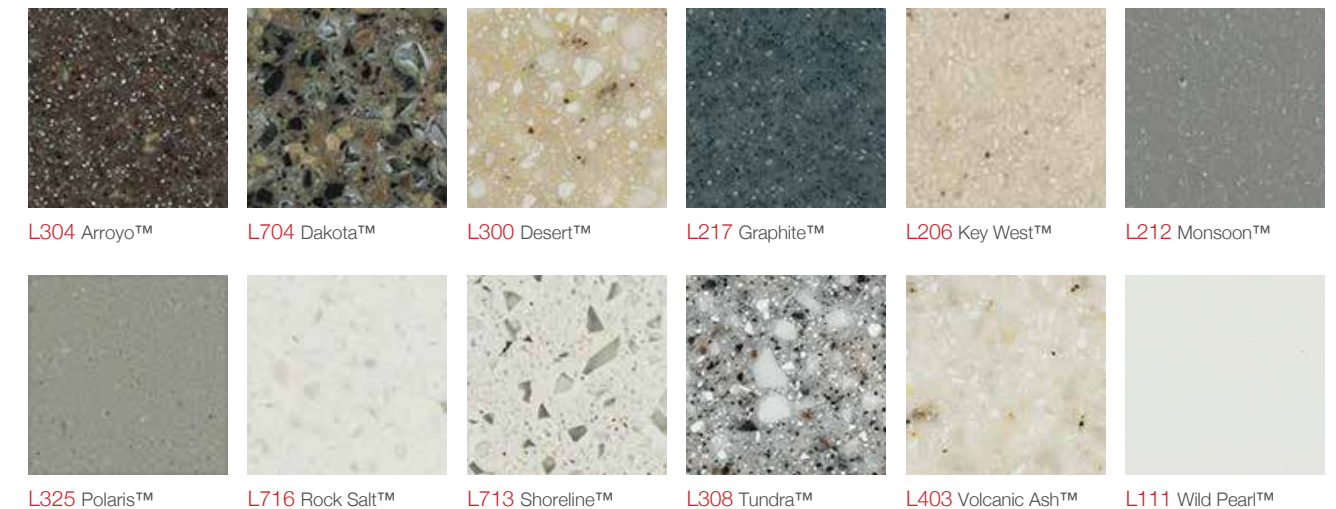

Please Note: 92+ design options available. Tables include a predrilled 3/4" plywood insert for easy base attachment. Due to the yielding of this material, Livingstone solid surface tables are quote only. Please contact Baltix for pricing.

Edge Profile Options

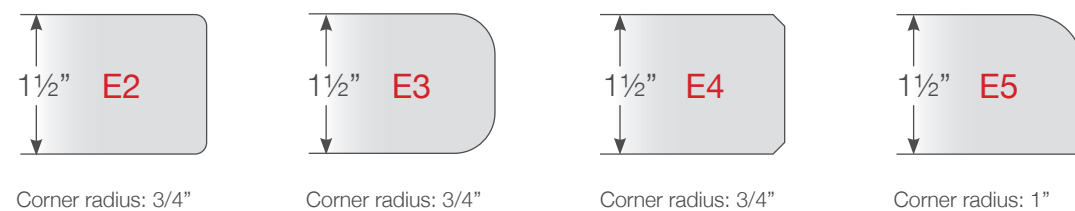

Corner radius: 3/4" Corner radius: 3/4" Corner radius: 3/4" Corner radius: 1"

Edge Profile Options

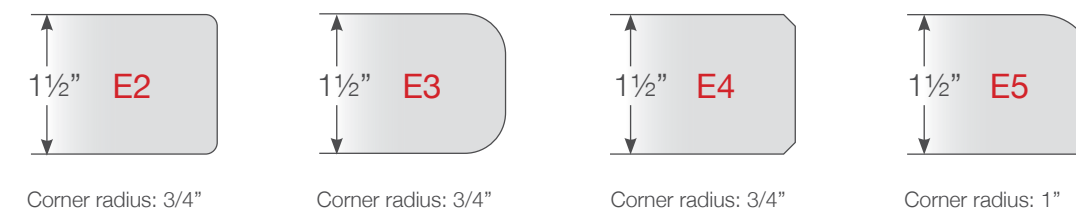

Corner radius: 3/4" Corner radius: 3/4" Corner radius: 3/4" Corner radius: 1"



Sustainable Base Materials & Finishes



Steel Bases

Baltix offers a comprehensive collection of steel base styles that can fit in any commercial environment. These bases are built using 14 gauge steel and the mounting plates are made of 7 gauge steel with welded reinforcement. All welded joints are ground smooth for commercial applications. These bases come in 19 standard VOC-free powder coat color options. Baltix offers bases at custom heights per your specification. We also offer a wide variety of base add-on options: locking casters, flip-top mechanism (nesting), folding, adjustable height, wire management and more. All steel bases are commercial-grade and support BIFMA standards. The steel utilized to manufacture these bases includes 30+% recycled content.



Cast Iron Bases

Our cast iron bases are made from 100% recycled grey iron (used or scrap) material. These bases will not bend or flex and are dent- and impact-resistant. The cast iron bases are finished with a non VOC black wrinkle powder coat that will stand up to cleaning products, shoe marks, and also deters rust. These commercial-grade bases are engineered with added wall thickness and support ridges on the underside to provide added strength.



Powder Coat Color Selection

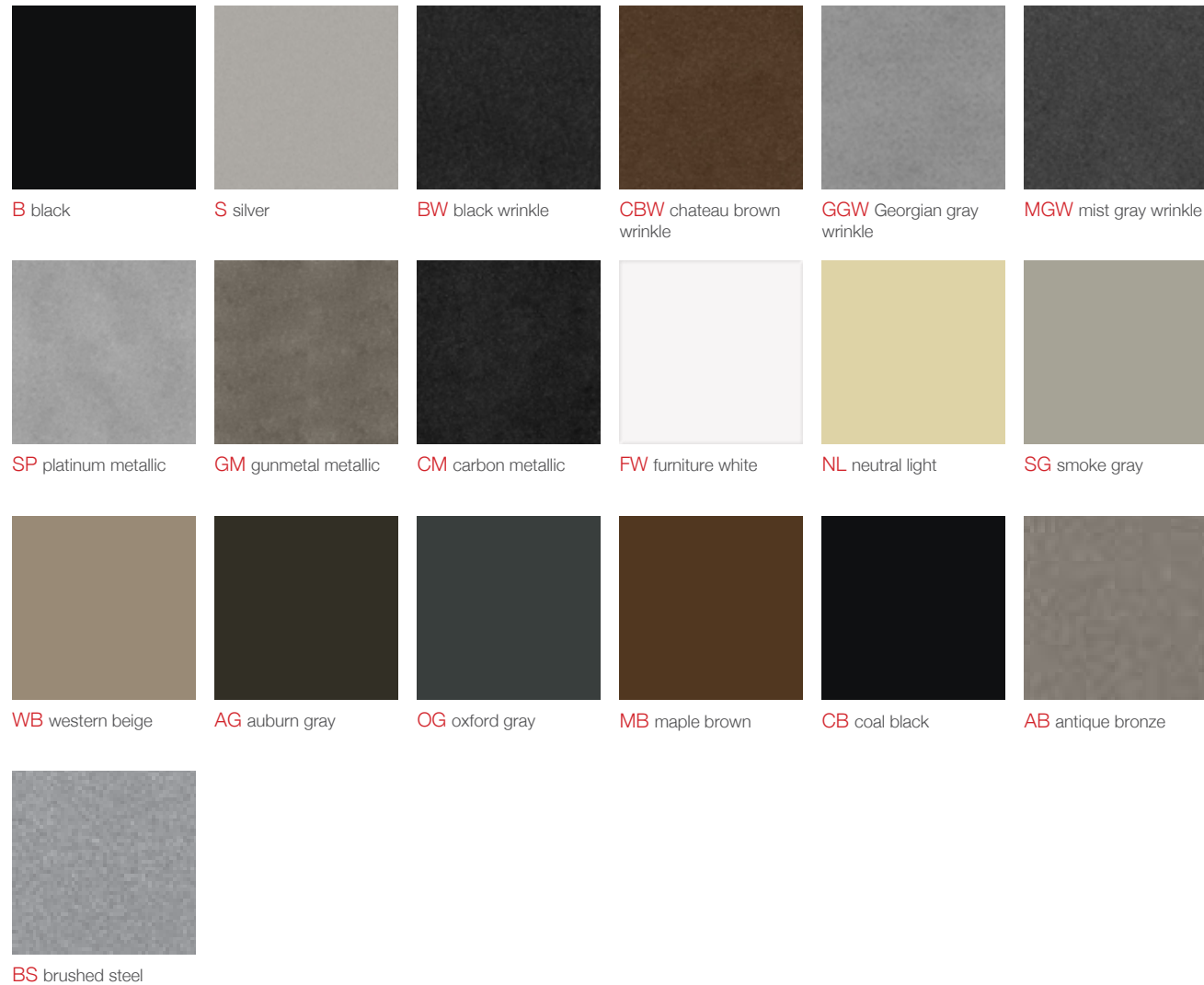

Material Color

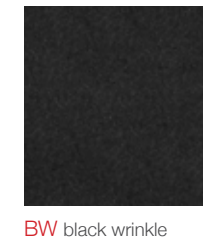

Stainless Steel Bases

Classic design meets beautiful finish with our stainless steel square base. This table base is made from 304 grade stainless steel and is offered at standard or bar height (optional footring available). 304 grade stainless steel offers impressive strength as well as incredible corrosion resistance.



Material Color



Hospitality & Multi-use Tables



Hospitality & Multi-use Base Styles



Mode Base (BM)
p.28



Taper Base (BE)
p.30



Zone Base (BZ)
p.32



Toob Base (BT)
p.34



Slim Square Base (BSS)
p.52



Slim Squircle Base (BSQ)
p.54



Stainless Steel Square Base (BST)
p.56



Floor Mounted Base (BFM)
p.58



Double Column Flip-Top Toob Base (BTF)
p.36



Wedge Base (BW)
p.38



Ingot Base (BI)
p.40



Arch Base (BA)
p.42



Heavy Round Base (BHR)
p.60



Trumpet Base (BR)
p.62



Picture Frame Base (BPF)
p.64



Angled Base (BAC)
p.66



Double Column Flip-Top Arch Base (BAF)
p.44



Swoop Base (BS)
p.46



Bold Base (BB)
p.48



Slim Round Base (BSD)
p.50



Ornate Base (BO)
p.68



Cantilevered Base (BC)
p.69

Mode Base Tables (BM)



X-base



T-base

Part # Assessment

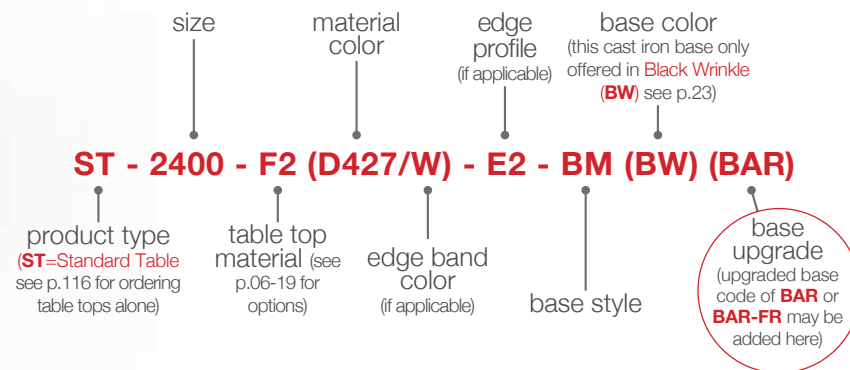

952.698.1220

Upgrades and Add-ons

Bar Height **BAR**

40.25" h base to replace standard "X" baseAdd \$35 list per table
 40.25" h base to replace standard "T" baseAdd \$70 list per table



Bar Height "X" Base with Foot Ring **BAR-FR**

40.25" h "X" base with 19" diameter foot ring to replace standard "X" base.....Add \$150 list per table



List Pricing

Size	Table Top Finish and Edge Type										
	F2	F4	F6	F7	F8	F16	F17	F18	F19-F24		
	Wilson® Standard Laminate with Matching Edgeband	Wilson® Standard Laminate with Multiply	Forbo® Linoleum on Birch Edgeband	Forbo® Linoleum with BioEdge™ Multiply	Forbo® Linoleum on Birch	Powder Coated MDF	Nuxite®	Solid Hardwood (Butcher Block)	Cambria® Quartz		
24" Ø (2400)	\$269	\$326	\$284	\$359	\$311	\$1,233	\$472	\$1,046	call for quote		
30" Ø (3000)	\$386	\$449	\$427	\$494	\$386	\$1,706	\$678	\$1,623	call for quote		
36" Ø (3600)	\$659	\$832	\$618	\$858	\$536	\$2,279	\$926	\$2,253	call for quote		
42" Ø (4200)	\$740	\$950	\$864	\$1,145	\$654	\$3,538	\$1,209	\$3,099	call for quote		
48" Ø (4800)	\$943	\$1,205	\$1,111	\$1,445	\$853	\$4,696	\$1,723	\$4,156	call for quote		
60" Ø (6000)	\$1,385	\$1,734	\$1,546	\$1,873	N/A	N/A	\$2,525	\$6,294	call for quote		
24"x24" (2424)	\$269	\$326	\$281	\$359	\$311	\$1,233	\$472	\$1,046	call for quote		
30"x30" (3030)	\$382	\$449	\$419	\$494	\$386	\$1,706	\$678	\$1,623	call for quote		
36"x36" (3636)	\$680	\$856	\$635	\$883	\$560	\$2,304	\$950	\$2,278	call for quote		
42"x42" (4242)	\$733	\$950	\$860	\$1,145	\$654	\$3,538	\$1,209	\$3,099	call for quote		
48"x48" (4848)	\$935	\$1,205	\$1,100	\$1,445	\$853	\$4,696	\$1,723	\$4,156	call for quote		
24"x30" (2430)	\$318	\$393	\$333	\$434	\$367	\$1,578	\$566	\$1,286	call for quote		
30"x36" (3036)	\$506	\$607	\$517	\$659	\$498	\$1,942	\$768	\$1,912	call for quote		
24"x48" (2448)	\$516	\$639	\$542	\$707	\$557	\$2,102	\$909	\$2,346	call for quote		
24"x60" (2460)	\$718	\$804	\$887	\$827	\$688	\$2,552	\$1,089	\$2,863	call for quote		
24"x72" (2472)	\$789	\$996	\$786	\$1,067	\$763	\$2,998	\$1,262	\$3,381	call for quote		
30"x48" (3048)	\$632	\$782	\$662	\$857	\$632	\$2,537	\$1,119	\$2,871	call for quote		
30"x60" (3060)	\$819	\$906	\$864	\$973	\$707	\$3,088	\$1,344	\$3,519	call for quote		
30"x72" (3072)	\$861	\$1,401	\$943	\$1,603	\$894	\$3,643	\$1,569	\$4,168	call for quote		



****For power & data options and wire management, see pages 112-115.**

Taper Base Tables



Upgrades and Add-ons



Bar Height **BAR**

40.75" h base to replace standard "X" baseAdd \$75 list per table
 40.75" h base to replace standard "T" baseAdd \$150 list per table

Part # Assessment

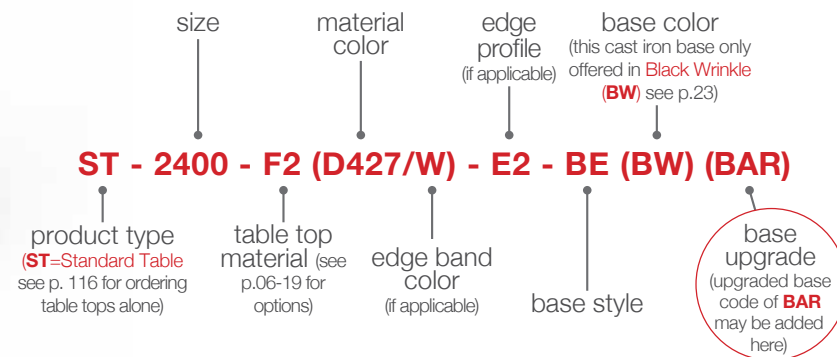

List Pricing

Size	Table Top Finish and Edge Type															
	F2	F4	F6	F7	F8	F16	F17	F18	F19-F24							
	24" Ø (2400)	30" Ø (3000)	36" Ø (3600)	42" Ø (4200)	48" Ø (4800)	60" Ø (6000)	24"x24" (2424)	30"x30" (3030)	36"x36" (3636)	42"x42" (4242)	48"x48" (4848)	24"x30" (2430)	30"x36" (3036)	30"x48" (3048)	30"x60" (3060)	30"x72" (3072)
	\$433	\$582	\$921	\$977	\$1,037	\$1,781	\$433	\$579	\$917	\$969	\$1,029	\$515	\$744	\$943	\$1,130	\$1,171
	\$489	\$646	\$1,093	\$1,187	\$1,299	\$2,129	\$489	\$646	\$1,093	\$1,187	\$1,299	\$590	\$845	\$1,093	\$1,216	\$1,711
	\$448	\$624	\$879	\$1,101	\$1,206	\$1,942	\$444	\$616	\$872	\$1,097	\$1,194	\$530	\$755	\$973	\$1,175	\$1,254
	\$523	\$691	\$1,119	\$1,382	\$1,539	\$2,268	\$523	\$691	\$891	\$1,097	\$1,539	\$631	\$898	\$1,168	\$1,284	\$1,914
	\$474	\$582	\$797	\$891	\$947	N/A	\$474	\$582	\$891	\$947	\$947	\$564	\$737	\$943	\$1,018	\$1,205
	\$1,397	\$1,902	\$2,541	\$3,774	\$4,791	N/A	\$1,397	\$1,902	\$2,541	\$3,774	\$4,791	\$1,775	\$2,180	\$2,848	\$3,399	\$3,954
	\$635	\$875	\$1,187	\$1,446	\$1,817	\$2,921	\$635	\$875	\$1,187	\$1,446	\$1,817	\$762	\$1,007	\$1,430	\$1,655	\$1,880
	\$1,209	\$1,820	\$2,514	\$3,336	\$4,251	\$6,689	\$1,209	\$1,820	\$2,514	\$3,336	\$4,251	\$1,482	\$2,150	\$3,181	\$3,830	\$4,479
	call for quote	call for quote	call for quote	call for quote	call for quote	call for quote	call for quote	call for quote	call for quote	call for quote	call for quote	call for quote	call for quote	call for quote	call for quote	call for quote



****For power & data options and wire management, see pages 112-115.**

Zone Base Tables (BZ)

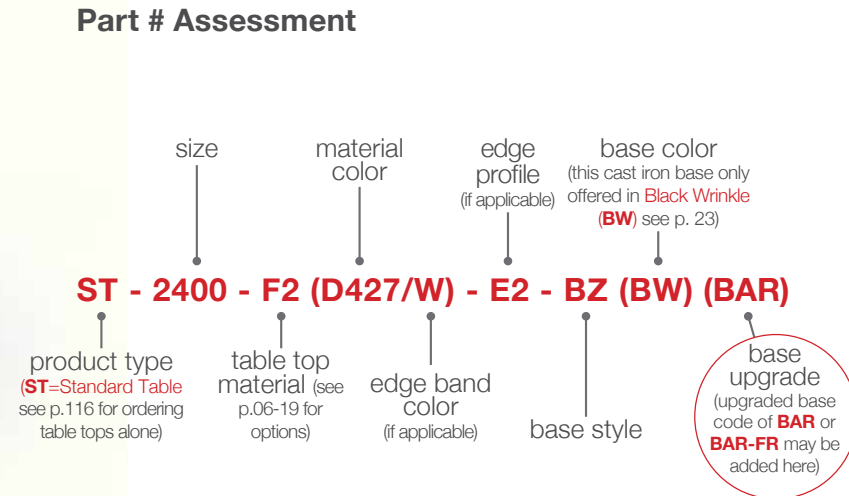

Upgrades and Add-ons



Bar Height BAR

41.5" h disk base to replace standard disk base.....Add \$35 list per table



Bar Height Disk Base with Foot Ring BAR-FR

41.5" h disk base with 19" diameter foot ring to replace standard disk base.....Add \$150 list per table

List Pricing

Size	Table Top Finish and Edge Type											
	F2	F4	F6	F7	F8	F16	F17	F18	F19-F24			
	Wilsonart® Standard Laminate with Matching Edge Band.....(p.06)	Wilsonart® Standard Laminate on Birch Multiply.....(p.07)	Forbo® Linoleum on Birch Edgeband.....(p.08)	Forbo® Linoleum with BioEdge™ Multiply.....(p.09)	Powder Coated MDF.....(p.10)	Nuxite®.....(p.11)	Solid Hardwood (Butcher Block).....(p.12)	Cambria® Quartz.....(p.13)	(p.14-19)			
	24" Ø (2400)	\$343	\$399	\$358	\$433	\$384	\$1,306	\$545	\$1,119	call for quote		
	30" Ø (3000)	\$459	\$523	\$500	\$568	\$459	\$1,779	\$751	\$1,696	call for quote		
	36" Ø (3600)	\$733	\$905	\$691	\$931	\$609	\$2,353	\$999	\$2,326	call for quote		
	42" Ø (4200)	\$838	\$1,048	\$962	\$1,243	\$752	\$3,635	\$1,307	\$3,197	call for quote		
	48" Ø (4800)	\$898	\$1,160	\$1,067	\$1,400	\$808	\$4,652	\$1,678	\$4,112	call for quote		
60" Ø (6000)	\$1,646	\$1,995	\$1,807	\$2,134	N/A	N/A	\$2,786	\$6,555	call for quote			
	24"x24" (2424)	\$343	\$399	\$354	\$433	\$384	\$1,306	\$545	\$1,119	call for quote		
	30"x30" (3030)	\$455	\$523	\$493	\$568	\$459	\$1,779	\$751	\$1,696	call for quote		
	36"x36" (3636)	\$729	\$905	\$684	\$931	\$609	\$2,353	\$999	\$2,326	call for quote		
	42"x42" (4242)	\$830	\$1,048	\$958	\$1,243	\$752	\$3,635	\$1,307	\$3,197	call for quote		
	48"x48" (4848)	\$890	\$1,160	\$1,055	\$1,400	\$808	\$4,652	\$1,678	\$4,112	call for quote		
	24"x30" (2430)	\$391	\$466	\$406	\$508	\$440	\$1,651	\$639	\$1,359	call for quote		
	30"x36" (3036)	\$628	\$729	\$639	\$782	\$620	\$2,064	\$890	\$2,034	call for quote		

Toob Base Tables (BT)



Part # Assessment

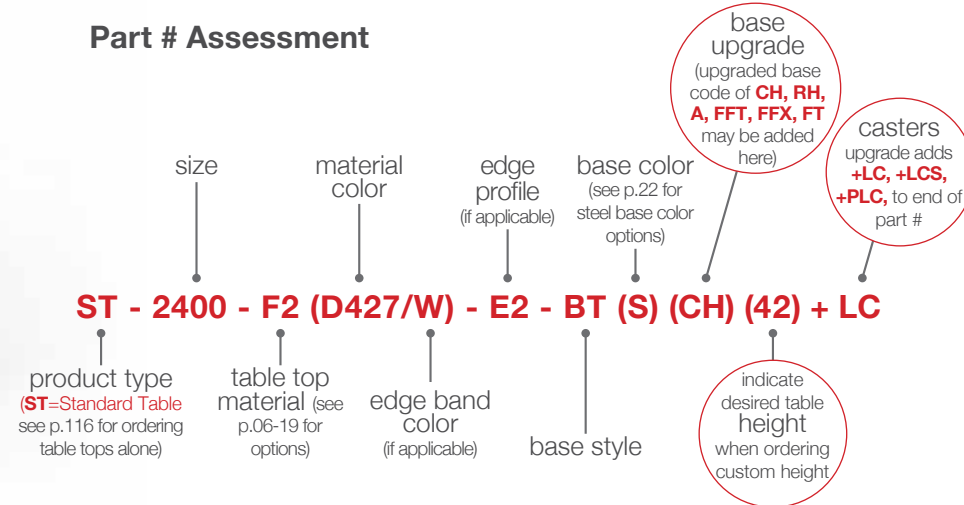

Upgrades and Add-ons



2" Standard Plastic Locking Casters +LC

Dual wheel locking casters, black (4 per table).....Add \$60 list per table



2" Soft Rubber Locking Casters +LCS

More non-slip than our standard 2" locking caster, allowing tables to stay put on polished floors. Dual wheel locking casters, black (4 per table).....Add \$80 list per table



2" Premium Locking Casters +PLC

Premium silver casters are available on tables with Toob and Ingot bases only. Dual wheel locking casters, black and silver (4 per table)Add \$80 list per table



Custom Height CH

To replace standard "X" baseAdd \$50 list per table (specify table height in inches)
To replace standard "T" baseAdd \$100 list per table (specify table height in inches)



Ratchet Height Adjustability for Toob "T" Base RH

Available on our Toob T base only. Simply grab the edge of the table top and lift to raise. Ratchet will click incrementally until it reaches the top, then it will lower back down.

Base height (with standard levelers): 23" to 32.5" (9.5" range)

To replace standard Toob "T" baseAdd \$330 list per table



Asymmetrical (Offset) Base A

To replace standard centered "T" base.....Add \$35 list per table



Flip-Top Mechanism for Nested Storage "T" Base FFT

Easy trigger mechanism can be operated from either end of the table! Includes locking casters. To replace standard "T" baseAdd \$310 list per table



Flip-Top Mechanism for "X" Base FFX

Includes locking casters. To replace standard "X" base (max. table top 36"x36").....Add \$150 list per table



Folding Mechanism for Stacking "T" Base FT

To replace standard "T" baseAdd \$240 list per table
Note: 48" L table requires short-fold mechanism to allow legs to overlap and lay flat.....Add additional \$120 list per table



****For power & data options and wire management, see pages 112-115.**

List Pricing

Size	Table Top Finish and Edge Type									
	F2	F4	F6	F7	F8	F16	F17	F18	F19-F24	
24" Ø (2400)	\$476	\$532	\$491	\$566	\$517	\$1,440	\$679	\$1,252	call for quote	
30" Ø (3000)	\$594	\$658	\$635	\$703	\$594	\$1,914	\$886	\$1,831	call for quote	
36" Ø (3600)	\$892	\$1,065	\$851	\$1,091	\$768	\$2,512	\$1,158	\$2,486	call for quote	
42" Ø (4200)	\$950	\$1,160	\$1,074	\$1,355	\$864	\$3,748	\$1,419	\$3,309	call for quote	
48" Ø (4800)	\$1,025	\$1,287	\$1,194	\$1,527	\$935	\$4,779	\$1,805	\$4,239	call for quote	
60" Ø (6000)	\$1,652	\$2,001	\$1,813	\$2,139	N/A	N/A	\$2,792	\$6,561	call for quote	
24"x24" (2424)	\$476	\$532	\$487	\$566	\$517	\$1,440	\$679	\$1,252	call for quote	
30"x30" (3030)	\$590	\$658	\$628	\$703	\$594	\$1,914	\$886	\$1,831	call for quote	
36"x36" (3636)	\$888	\$1,065	\$843	\$1,091	\$768	\$2,512	\$1,158	\$2,486	call for quote	
42"x42" (4242)	\$943	\$1,160	\$1,070	\$1,355	\$864	\$3,748	\$1,419	\$3,309	call for quote	
48"x48" (4848)	\$1,202	\$1,472	\$1,367	\$1,712	\$1,119	\$4,963	\$1,989	\$4,423	call for quote	
24"x30" (2430)	\$525	\$600	\$540	\$641	\$574	\$1,785	\$772	\$1,492	call for quote	
30"x36" (3036)	\$716	\$817	\$727	\$869	\$708	\$2,152	\$978	\$2,122	call for quote	
24"x48" (2448)	\$731	\$855	\$758	\$923	\$773	\$2,318	\$1,125	\$2,561	call for quote	
24"x60" (2460)	\$934	\$1,020	\$1,103	\$1,043	\$904	\$2,768	\$1,305	\$3,079	call for quote	
24"x72" (2472)	\$1,005	\$1,211	\$1,001	\$1,283	\$979	\$3,214	\$1,478	\$3,596	call for quote	
30"x48" (3048)	\$851	\$1,001	\$881	\$1,076	\$851	\$2,756	\$1,338	\$3,090	call for quote	
30"x60" (3060)	\$1,038	\$1,125	\$1,083	\$1,192	\$926	\$3,307	\$1,563	\$3,738	call for quote	
30"x72" (3072)	\$1,080	\$1,620	\$1,162	\$1,822	\$1,113	\$3,862	\$1,788	\$4,387	call for quote	

Double Column Flip-Top Toob Base Tables (BTF)

Upgrades and Add-ons



Part # Assessment

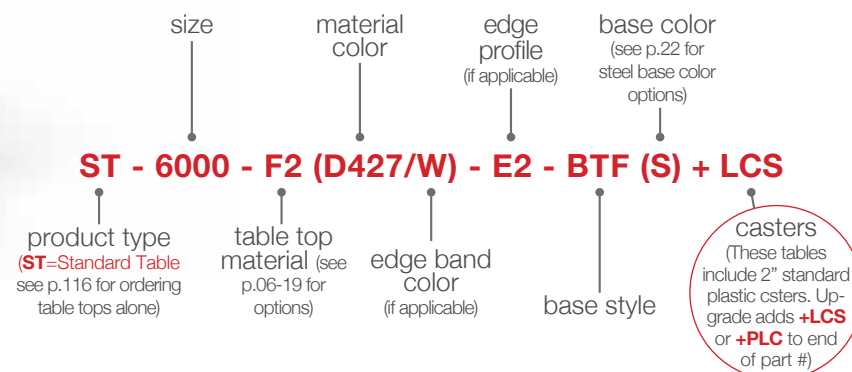

Please Note: These tables will include 2" standard plastic locking casters.



2" Soft Rubber Locking Casters **+LCS**

More non-slip than our standard 2" locking caster, allowing tables to stay put on polished floors. Dual wheel locking casters, black (4 per table).....Add \$80 list per table



2" Premium Locking Casters **+PLC**

Premium silver casters are available on tables with Toob and Ingot bases only. Dual wheel locking casters, black and silver (4 per table)Add \$80 list per table

List Pricing

Size	Table Top Finish and Edge Type			
	F2	F4	F6	F7
60" Ø (6000)	\$2,633	\$2,982	\$2,795	\$3,121
48"x48" (4848)	\$2,183	\$2,453	\$2,348	\$2,693

Wilsonart® Standard Laminate with Matching Edge Band.....(p.06)
 Wilsonart® Standard Laminate on Birch Multiply.....(p.07)
 Forbo® Linoleum with BioEdge™ Edgeband.....(p.08)
 Forbo® Linoleum on Birch Multiply.....(p.09)

Wedge Base Tables (BW)

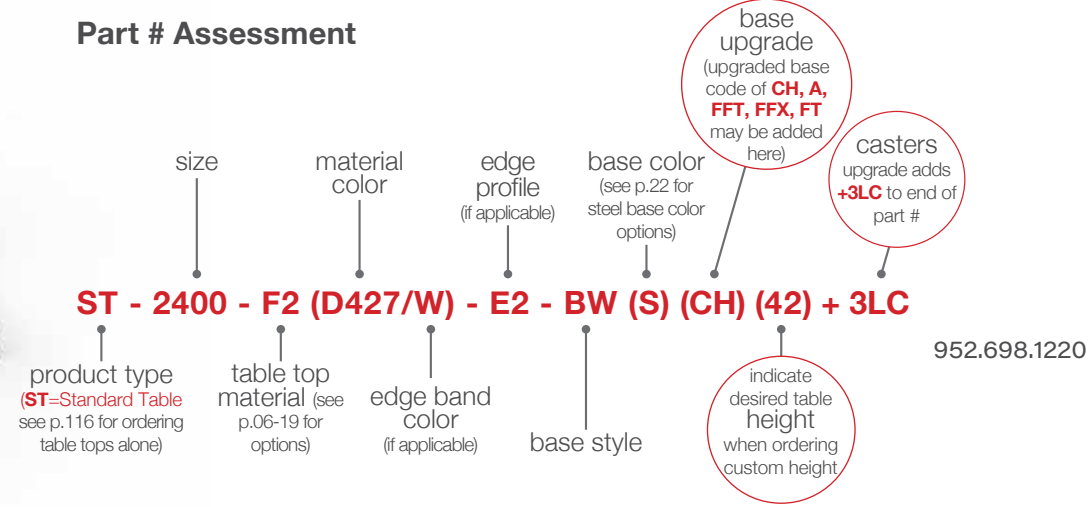

List Pricing

Size	Table Top Finish and Edge Type										
	F2	F4	F6	F7	F8	F16	F17	F18	F19-F24		
	24" Ø (2400)	\$634	\$690	\$649	\$724	\$675	\$1,598	\$836	\$1,410	call for quote	
	30" Ø (3000)	\$776	\$840	\$818	\$885	\$776	\$2,096	\$1,069	\$2,014	call for quote	
	36" Ø (3600)	\$1,073	\$1,245	\$1,031	\$1,271	\$949	\$2,693	\$1,339	\$2,666	call for quote	
	42" Ø (4200)	\$1,129	\$1,339	\$1,253	\$1,534	\$1,043	\$3,926	\$1,598	\$3,488	call for quote	
	24"x24" (2424)	\$634	\$690	\$645	\$724	\$675	\$1,598	\$836	\$1,410	call for quote	
	30"x30" (3030)	\$773	\$840	\$810	\$885	\$776	\$2,096	\$1,069	\$2,014	call for quote	
	36"x36" (3636)	\$1,069	\$1,245	\$1,024	\$1,271	\$949	\$2,693	\$1,339	\$2,666	call for quote	
	42"x42" (4242)	\$1,121	\$1,339	\$1,249	\$1,534	\$1,043	\$3,926	\$1,598	\$3,488	call for quote	
	24"x30" (2430)	\$683	\$758	\$698	\$799	\$731	\$1,943	\$930	\$1,650	call for quote	
	30"x36" (3036)	\$896	\$998	\$908	\$1,050	\$889	\$2,333	\$1,159	\$2,303	call for quote	
	24"x48" (2448)	\$911	\$1,035	\$938	\$1,103	\$953	\$2,498	\$1,305	\$2,741	call for quote	
	24"x60" (2460)	\$1,114	\$1,200	\$1,283	\$1,223	\$1,084	\$2,948	\$1,485	\$3,259	call for quote	
	24"x72" (2472)	\$1,185	\$1,391	\$1,181	\$1,463	\$1,159	\$3,394	\$1,658	\$3,776	call for quote	
	30"x48" (3048)	\$1,043	\$1,193	\$1,073	\$1,268	\$1,043	\$2,948	\$1,530	\$3,281	call for quote	
	30"x60" (3060)	\$1,230	\$1,316	\$1,275	\$1,384	\$1,118	\$3,499	\$1,755	\$3,930	call for quote	
	30"x72" (3072)	\$1,271	\$1,811	\$1,354	\$2,014	\$1,305	\$4,054	\$1,980	\$4,579	call for quote	

Upgrades and Add-ons



3" Standard Plastic Locking Casters +3LC

Dual wheel locking casters, black (4 per table).....Add \$100 list per table



Custom Height CH

To replace standard "X" baseAdd \$50 list per table (specify table height in inches)
To replace standard "T" baseAdd \$100 list per table (specify table height in inches)



Asymmetrical (Offset) Base A

To replace standard centered "T" base.....Add \$35 list per table



Flip-Top Mechanism for Nested Storage "T" Base FFT

Easy trigger mechanism can be operated from either end of the table! Includes locking casters.
To replace standard "T" baseAdd \$310 list per table



Flip-Top Mechanism for "X" Base FFX

Includes locking casters.
To replace standard "X" base (max. table top 36").....Add \$150 list per table



Folding Mechanism for Stacking "T" Base FT

To replace standard "T" baseAdd \$240 list per table
Note: 48" L table requires short-fold mechanism to allow legs to overlap and lay flat.....Add additional \$120 list per table



****For power & data options and wire management, see pages 112-115.**

Ingot Base Tables (BI)

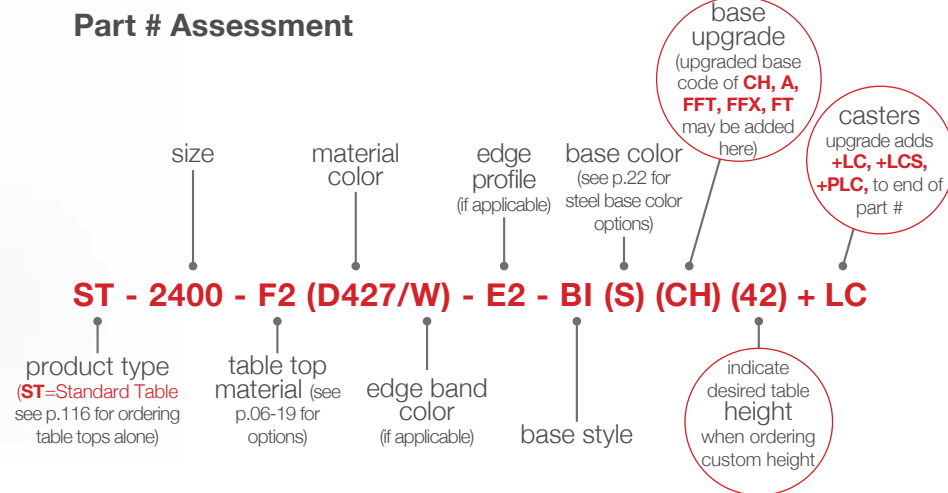
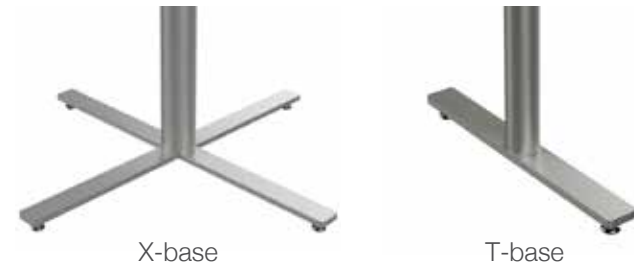

List Pricing

Size	Table Top Finish and Edge Type									
	F2	F4	F6	F7	F8	F16	F17	F18	F19-F24	
	24" Ø (2400)	\$693	\$750	\$708	\$783	\$735	\$1,657	\$896	\$1,470	call for quote
	30" Ø (3000)	\$832	\$896	\$874	\$941	\$832	\$2,152	\$1,125	\$2,070	call for quote
	36" Ø (3600)	\$1,168	\$1,341	\$1,127	\$1,367	\$1,044	\$2,788	\$1,434	\$2,762	call for quote
	42" Ø (4200)	\$1,252	\$1,462	\$1,376	\$1,657	\$1,166	\$4,050	\$1,721	\$3,611	call for quote
	48" Ø (4800)	\$1,312	\$1,575	\$1,481	\$1,815	\$1,222	\$5,066	\$2,092	\$4,526	call for quote
	24"x24" (2424)	\$693	\$750	\$705	\$783	\$735	\$1,657	\$896	\$1,470	call for quote
	30"x30" (3030)	\$829	\$896	\$866	\$941	\$832	\$2,152	\$1,125	\$2,070	call for quote
	36"x36" (3636)	\$1,164	\$1,341	\$1,119	\$1,367	\$1,044	\$2,788	\$1,434	\$2,762	call for quote
	42"x42" (4242)	\$1,245	\$1,462	\$1,372	\$1,657	\$1,166	\$4,050	\$1,721	\$3,611	call for quote
	24"x30" (2430)	\$773	\$848	\$788	\$889	\$822	\$2,033	\$1,021	\$1,741	call for quote
	30"x36" (3036)	\$961	\$1,062	\$972	\$1,114	\$953	\$2,397	\$1,223	\$2,367	call for quote
	24"x48" (2448)	\$986	\$1,110	\$1,012	\$1,177	\$1,027	\$2,572	\$1,380	\$2,816	call for quote
	24"x60" (2460)	\$1,189	\$1,275	\$1,357	\$1,297	\$1,159	\$3,022	\$1,560	\$3,334	call for quote
	24"x72" (2472)	\$1,260	\$1,466	\$1,256	\$1,537	\$1,234	\$3,469	\$1,732	\$3,851	call for quote
	30"x48" (3048)	\$1,125	\$1,275	\$1,155	\$1,350	\$1,125	\$3,030	\$1,613	\$3,364	call for quote
	30"x60" (3060)	\$1,313	\$1,399	\$1,358	\$1,466	\$1,200	\$3,581	\$1,838	\$4,013	call for quote
	30"x72" (3072)	\$1,354	\$1,894	\$1,436	\$2,096	\$1,388	\$4,136	\$2,063	\$4,661	call for quote

Upgrades and Add-ons



2" Standard Plastic Locking Casters +LC

Dual wheel locking casters, black (4 per table).....Add \$60 list per table



2" Soft Rubber Locking Casters +LCS

More non-slip than our standard 2" locking caster, allowing tables to stay put on polished floors. Dual wheel locking casters, black (4 per table).....Add \$80 list per table



2" Premium Locking Casters +PLC

Premium silver casters are available on tables with Toob and Ingot bases only. Dual wheel locking casters, black and silver (4 per table)Add \$80 list per table



Custom Height CH

To replace standard "X" baseAdd \$50 list per table (specify table height in inches)
To replace standard "T" baseAdd \$100 list per table (specify table height in inches)



Asymmetrical (Offset) Base A

To replace standard centered "T" base.....Add \$35 list per table



Flip-Top Mechanism for Nested Storage "T" Base FFT

Easy trigger mechanism can be operated from either end of the table! Includes locking casters. To replace standard "T" baseAdd \$310 list per table



Flip-Top Mechanism for "X" Base FFX

Includes locking casters. To replace standard "X" base (max. table top 36").....Add \$150 list per table



Folding Mechanism for Stacking "T" Base FT

To replace standard "T" baseAdd \$240 list per table
Note: 48" L table requires short-fold mechanism to allow legs to overlap and lay flat.....Add additional \$120 list per table



****For power & data options and wire management, see pages 112-115.**

Arch Base Tables (BA)



Part # Assessment

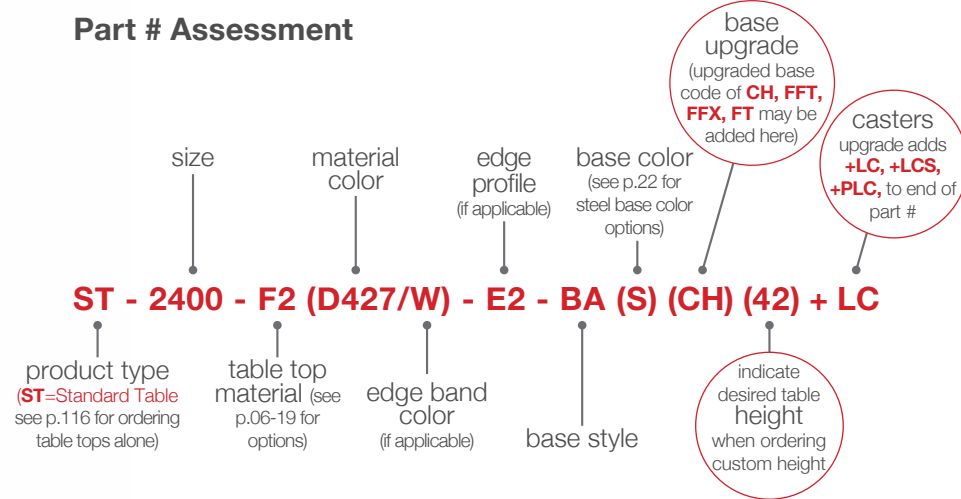

Upgrades and Add-ons



2" Standard Plastic Locking Casters +LC

Dual wheel locking casters, black (4 per table).....Add \$60 list per table



2" Soft Rubber Locking Casters +LCS

More non-slip than our standard 2" locking caster, allowing tables to stay put on polished floors. Dual wheel locking casters, black (4 per table).....Add \$80 list per table



2" Premium Locking Casters +PLC

Premium silver casters are available on tables with Toob and Ingot bases only. Dual wheel locking casters, black and silver (4 per table)Add \$80 list per table



Custom Height CH

To replace standard "X" baseAdd \$50 list per table (specify table height in inches)
To replace standard "T" baseAdd \$100 list per table (specify table height in inches)



Flip-Top Mechanism for Nested Storage "T" Base FFT

Easy trigger mechanism can be operated from either end of the table! Includes locking casters. To replace standard "T" baseAdd \$310 list per table



Flip-Top Mechanism for "X" Base FFX

Includes locking casters. To replace standard "X" base (max. table top 36"x36").....Add \$150 list per table



Folding Mechanism for Stacking "T" Base FT

To replace standard "T" baseAdd \$240 list per table
Note: 48" L table requires short-fold mechanism to allow legs to overlap and lay flat.....Add additional \$120 list per table



****For power & data options and wire management, see pages 112-115.**

List Pricing

Size	Table Top Finish and Edge Type									
	F2	F4	F6	F7	F8	F16	F17	F18	F19-F24	
24" Ø (2400)	\$610	\$666	\$625	\$700	\$651	\$1,574	\$812	\$1,386	call for quote	
30" Ø (3000)	\$734	\$798	\$776	\$843	\$734	\$2,054	\$1,027	\$1,972	call for quote	
36" Ø (3600)	\$1,010	\$1,182	\$969	\$1,209	\$886	\$2,630	\$1,276	\$2,604	call for quote	
42" Ø (4200)	\$1,108	\$1,318	\$1,232	\$1,513	\$1,022	\$3,906	\$1,577	\$3,467	call for quote	
48" Ø (4800)	\$1,168	\$1,431	\$1,337	\$1,671	\$1,078	\$4,922	\$1,948	\$4,382	call for quote	
60" Ø (6000)	\$2,166	\$2,515	\$2,327	\$2,654	N/A	N/A	\$3,306	\$7,075	call for quote	
24"x24" (2424)	\$610	\$666	\$621	\$700	\$651	\$1,574	\$812	\$1,386	call for quote	
30"x30" (3030)	\$731	\$798	\$768	\$843	\$734	\$2,054	\$1,027	\$1,972	call for quote	
36"x36" (3636)	\$1,006	\$1,182	\$961	\$1,209	\$886	\$2,630	\$1,276	\$2,604	call for quote	
42"x42" (4242)	\$1,101	\$1,318	\$1,228	\$1,513	\$1,022	\$3,906	\$1,577	\$3,467	call for quote	
48"x48" (4848)	\$1,716	\$1,986	\$1,881	\$2,226	\$1,634	\$5,477	\$2,504	\$4,937	call for quote	
24"x30" (2430)	\$659	\$734	\$674	\$775	\$707	\$1,919	\$906	\$1,626	call for quote	
30"x36" (3036)	\$854	\$956	\$866	\$1,008	\$847	\$2,291	\$1,117	\$2,261	call for quote	
24"x48" (2448)	\$731	\$855	\$758	\$923	\$773	\$2,318	\$1,125	\$2,561	call for quote	
24"x60" (2460)	\$934	\$1,020	\$1,103	\$1,043	\$904	\$2,768	\$1,305	\$3,079	call for quote	
24"x72" (2472)	\$1,005	\$1,211	\$1,001	\$1,283	\$979	\$3,214	\$1,478	\$3,596	call for quote	
30"x48" (3048)	\$848	\$998	\$878	\$1,073	\$848	\$2,753	\$1,335	\$3,086	call for quote	
30"x60" (3060)	\$1,035	\$1,121	\$1,080	\$1,189	\$923	\$3,304	\$1,560	\$3,735	call for quote	
30"x72" (3072)	\$1,076	\$1,616	\$1,159	\$1,819	\$1,110	\$3,859	\$1,785	\$4,384	call for quote	

Double Column Flip-Top Arch Base Tables (BAF)

Upgrades and Add-ons

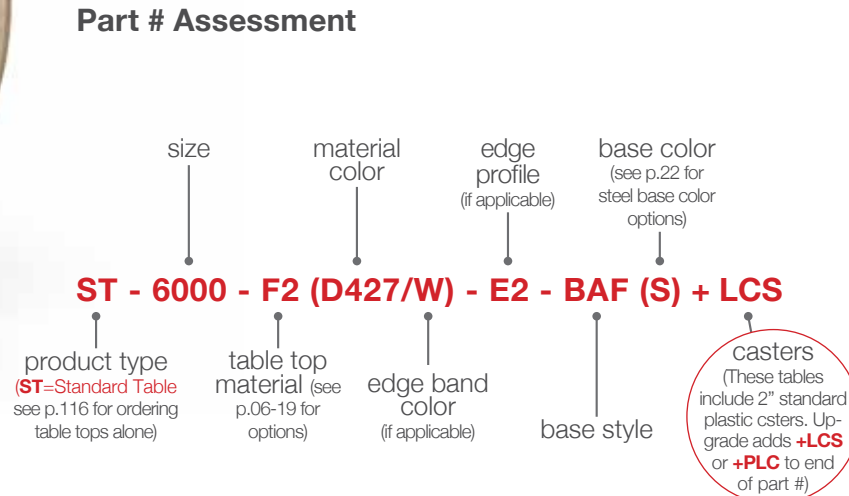

Please Note: These tables will include 2" standard plastic locking casters.



2" Soft Rubber Locking Casters +LCS

More non-slip than our standard 2" locking caster, allowing tables to stay put on polished floors. Dual wheel locking casters, black (4 per table).....Add \$80 list per table



2" Premium Locking Casters +PLC

Premium silver casters are available on tables with Toob and Ingot bases only. Dual wheel locking casters, black and silver (4 per table)Add \$80 list per table

List Pricing

Size	Table Top Finish and Edge Type				
	F2	F4	F6	F7	
60" Ø (6000)	\$2,852	\$3,201	\$3,013	\$3,340	
48"x48" (4848)	\$2,402	\$2,672	\$2,567	\$2,912	

Wilsonart® Standard Laminate with Matching Edge Band.....(p.06)
 Wilsonart® Standard Laminate on Birch Multiply.....(p.07)
 Forbo® Linoleum with BioEdge™ Edgeband.....(p.08)
 Forbo® Linoleum on Birch Multiply.....(p.09)

Swoop Base Tables (BS)

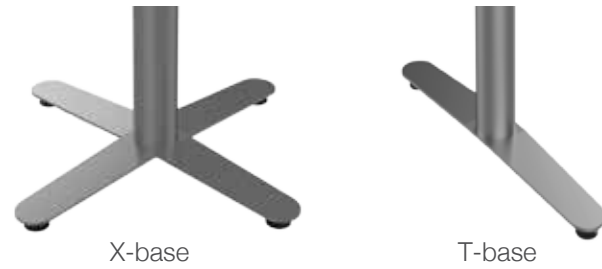

Part # Assessment

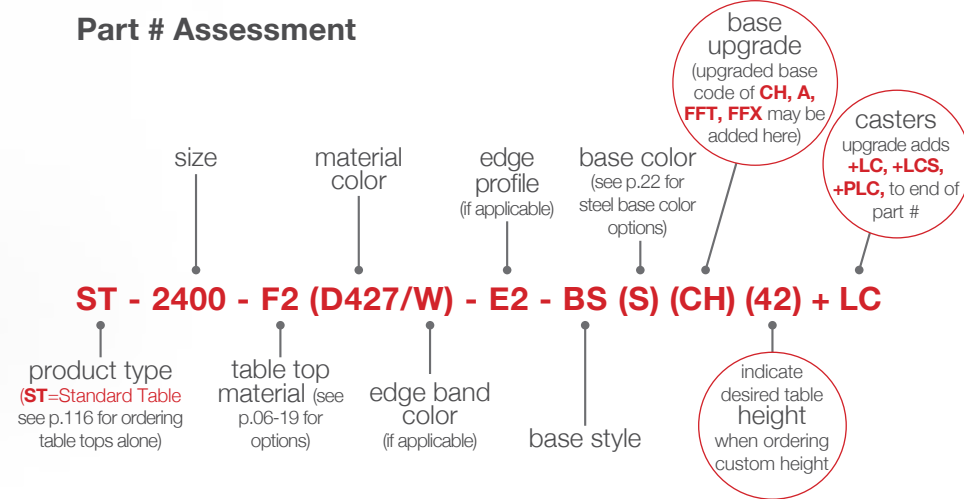

List Pricing

Size	Table Top Finish and Edge Type											
	F2	F4	F6	F7	F8	F16	F17	F18	F19-F24			
	24" Ø (2400)	\$540	\$596	\$555	\$630	\$581	\$1,504	\$742	\$1,316	call for quote		
	30" Ø (3000)	\$659	\$723	\$701	\$768	\$659	\$1,979	\$952	\$1,897	call for quote		
	36" Ø (3600)	\$933	\$1,106	\$892	\$1,132	\$809	\$2,553	\$1,199	\$2,527	call for quote		
	42" Ø (4200)	\$1,063	\$1,273	\$1,187	\$1,468	\$977	\$3,860	\$1,532	\$3,422	call for quote		
	48" Ø (4800)	\$1,141	\$1,403	\$1,309	\$1,643	\$1,051	\$4,894	\$1,921	\$4,354	call for quote		
	24"x24" (2424)	\$540	\$596	\$551	\$630	\$581	\$1,504	\$742	\$1,316	call for quote		
	30"x30" (3030)	\$656	\$723	\$693	\$768	\$659	\$1,979	\$952	\$1,897	call for quote		
	36"x36" (3636)	\$929	\$1,106	\$884	\$1,132	\$809	\$2,553	\$1,199	\$2,527	call for quote		
	42"x42" (4242)	\$1,055	\$1,273	\$1,183	\$1,468	\$977	\$3,860	\$1,532	\$3,422	call for quote		
	24"x30" (2430)	\$589	\$664	\$604	\$705	\$637	\$1,849	\$836	\$1,556	call for quote		
	30"x36" (3036)	\$779	\$881	\$791	\$933	\$772	\$2,216	\$1,042	\$2,186	call for quote		
	24"x48" (2448)	\$789	\$912	\$815	\$980	\$830	\$2,375	\$1,182	\$2,619	call for quote		
	24"x60" (2460)	\$991	\$1,077	\$1,160	\$1,100	\$961	\$2,825	\$1,362	\$3,136	call for quote		
	24"x72" (2472)	\$1,062	\$1,269	\$1,059	\$1,340	\$1,036	\$3,271	\$1,535	\$3,654	call for quote		
	30"x48" (3048)	\$911	\$1,061	\$941	\$1,136	\$911	\$2,816	\$1,399	\$3,150	call for quote		
	30"x60" (3060)	\$1,099	\$1,185	\$1,144	\$1,253	\$986	\$3,368	\$1,624	\$3,799	call for quote		
	30"x72" (3072)	\$1,140	\$1,680	\$1,223	\$1,883	\$1,174	\$3,923	\$1,849	\$4,448	call for quote		

Upgrades and Add-ons



2" Standard Plastic Locking Casters +LC

Dual wheel locking casters, black (4 per table).....Add \$60 list per table



2" Soft Rubber Locking Casters +LCS

More non-slip than our standard 2" locking caster, allowing tables to stay put on polished floors. Dual wheel locking casters, black (4 per table).....Add \$80 list per table



2" Premium Locking Casters +PLC

Premium silver casters are available on tables with Toob and Ingot bases only. Dual wheel locking casters, black and silver (4 per table)Add \$80 list per table



Custom Height CH

To replace standard "X" baseAdd \$50 list per table (specify table height in inches)
To replace standard "T" baseAdd \$100 list per table (specify table height in inches)



Asymmetrical (Offset) Base A

To replace standard centered "T" base.....Add \$35 list per table



Flip-Top Mechanism for Nested Storage "T" Base FFT

Easy trigger mechanism can be operated from either end of the table! Includes locking casters. To replace standard "T" baseAdd \$310 list per table



Flip-Top Mechanism for "X" Base FFX

Includes locking casters. To replace standard "X" base (max. table top 36").....Add \$150 list per table



****For power & data options and wire management, see pages 112-115.**

Bold Base Tables (BB)

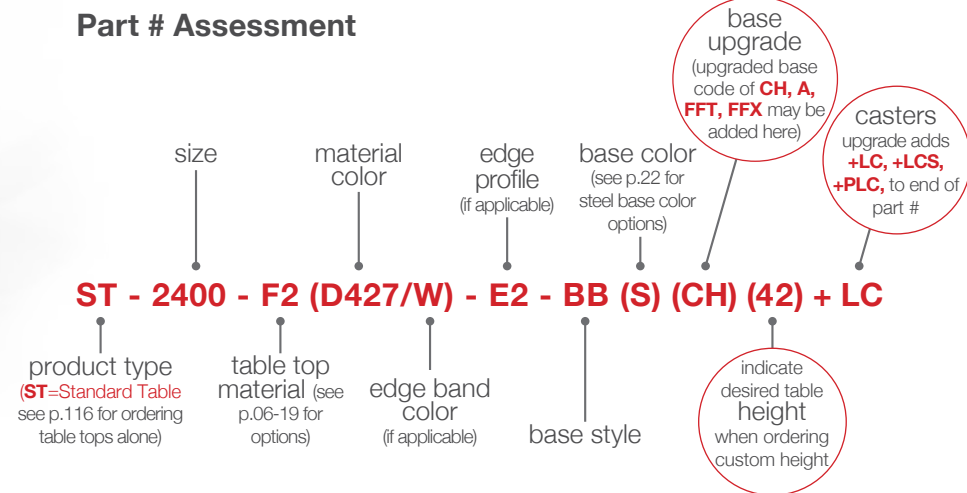
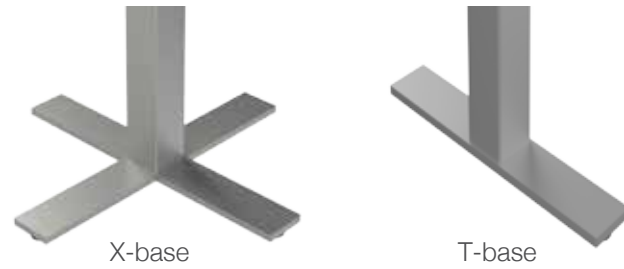

List Pricing

Size	Table Top Finish and Edge Type										
	F2	F4	F6	F7	F8	F16	F17	F18	F19-F24		
	24" Ø (2400)	\$576	\$632	\$591	\$666	\$617	\$1,539	\$778	\$1,352	call for quote	
	30" Ø (3000)	\$707	\$770	\$748	\$815	\$707	\$2,027	\$999	\$1,944	call for quote	
	36" Ø (3600)	\$993	\$1,166	\$952	\$1,192	\$870	\$2,613	\$1,260	\$2,587	call for quote	
	42" Ø (4200)	\$1,050	\$1,260	\$1,173	\$1,455	\$963	\$3,847	\$1,518	\$3,408	call for quote	
	48" Ø (4800)	\$1,124	\$1,387	\$1,293	\$1,627	\$1,034	\$4,878	\$1,904	\$4,338	call for quote	
	24"x24" (2424)	\$576	\$632	\$587	\$666	\$617	\$1,539	\$778	\$1,352	call for quote	
	30"x30" (3030)	\$703	\$770	\$740	\$815	\$707	\$2,027	\$999	\$1,944	call for quote	
	36"x36" (3636)	\$990	\$1,166	\$945	\$1,192	\$870	\$2,613	\$1,260	\$2,587	call for quote	
	42"x42" (4242)	\$1,042	\$1,260	\$1,170	\$1,455	\$963	\$3,847	\$1,518	\$3,408	call for quote	
	24"x30" (2430)	\$624	\$699	\$639	\$741	\$673	\$1,884	\$872	\$1,592	call for quote	
	30"x36" (3036)	\$827	\$928	\$838	\$980	\$819	\$2,263	\$1,089	\$2,233	call for quote	
	24"x48" (2448)	\$702	\$826	\$728	\$893	\$743	\$2,288	\$1,096	\$2,532	call for quote	
	24"x60" (2460)	\$904	\$991	\$1,073	\$1,013	\$874	\$2,738	\$1,276	\$3,049	call for quote	
	24"x72" (2472)	\$976	\$1,182	\$972	\$1,253	\$949	\$3,184	\$1,448	\$3,567	call for quote	
	30"x48" (3048)	\$835	\$985	\$865	\$1,060	\$835	\$2,740	\$1,322	\$3,073	call for quote	
	30"x60" (3060)	\$1,022	\$1,108	\$1,067	\$1,176	\$910	\$3,291	\$1,547	\$3,722	call for quote	
	30"x72" (3072)	\$1,063	\$1,603	\$1,146	\$1,806	\$1,097	\$3,846	\$1,772	\$4,371	call for quote	

Upgrades and Add-ons



2" Standard Plastic Locking Casters +LC

Dual wheel locking casters, black (4 per table).....Add \$60 list per table



2" Soft Rubber Locking Casters +LCS

More non-slip than our standard 2" locking caster, allowing tables to stay put on polished floors. Dual wheel locking casters, black (4 per table).....Add \$80 list per table



2" Premium Locking Casters +PLC

Premium silver casters are available on tables with Toob and Ingot bases only. Dual wheel locking casters, black and silver (4 per table)Add \$80 list per table



Custom Height CH

To replace standard "X" baseAdd \$50 list per table (specify table height in inches)
To replace standard "T" baseAdd \$100 list per table (specify table height in inches)



Asymmetrical (Offset) Base A

To replace standard centered "T" base.....Add \$35 list per table



Flip-Top Mechanism for Nested Storage "T" Base FFT

Easy trigger mechanism can be operated from either end of the table! Includes locking casters. To replace standard "T" baseAdd \$310 list per table



Flip-Top Mechanism for "X" Base FFX

Includes locking casters. To replace standard "X" base (max. table top 36").....Add \$150 list per table



****For power & data options and wire management, see pages 112-115.**

Slim Round Base Tables (BSD)

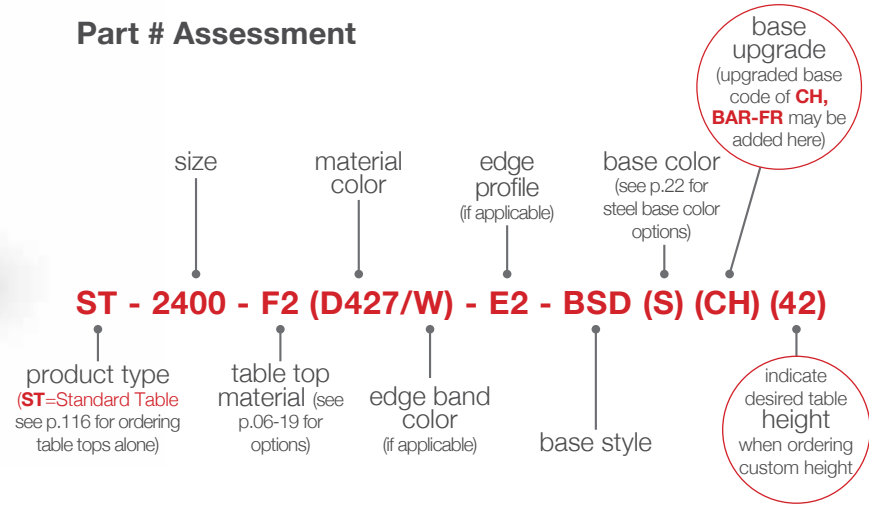

Upgrades and Add-ons



Custom Height CH

To replace standard disk base.....Add \$50 list per table (specify table height in inches)



Bar Height with Foot Ring @ 40.75"h BAR-FR

40.75"h disk base with foot ring to replace standard disk base
24"-30" tables have 14" dia. foot ring. 36"-48" tables have 19" dia. foot ring.Add \$150 list per table

List Pricing

Size	Table Top Finish and Edge Type											
	F2	F4	F6	F7	F8	F16	F17	F18	F19-F24			
	Wilsonart® Standard Laminate with Matching Edge Band Multiply	Wilsonart® Standard Laminate on Birch Edgeband Multiply	Forbo® Linoleum on Birch Edgeband Multiply	Forbo® Linoleum on Birch Edgeband Multiply	Powder Coated MDF Multiply	Nuxite® Multiply	Solid Hardwood (Butcher Block) Multiply	Cambria® Quartz Multiply				
24" Ø (2400)	\$646	\$702	\$661	\$736	\$687	\$1,610	\$848	\$1,422	call for quote			
30" Ø (3000)	\$762	\$826	\$803	\$871	\$762	\$2,082	\$1,055	\$2,000	call for quote			
36" Ø (3600)	\$1,036	\$1,208	\$995	\$1,235	\$912	\$2,656	\$1,302	\$2,630	call for quote			
42" Ø (4200)	\$1,125	\$1,335	\$1,249	\$1,530	\$1,039	\$3,922	\$1,594	\$3,484	call for quote			
48" Ø (4800)	\$1,293	\$1,555	\$1,461	\$1,795	\$1,203	\$5,046	\$2,073	\$4,506	call for quote			
24"x24" (2424)	\$646	\$702	\$657	\$736	\$687	\$1,610	\$848	\$1,422	call for quote			
30"x30" (3030)	\$758	\$826	\$796	\$871	\$762	\$2,082	\$1,055	\$2,000	call for quote			
36"x36" (3636)	\$1,032	\$1,208	\$987	\$1,235	\$912	\$2,656	\$1,302	\$2,630	call for quote			
42"x42" (4242)	\$1,117	\$1,335	\$1,245	\$1,530	\$1,039	\$3,922	\$1,594	\$3,484	call for quote			
24"x30" (2430)	\$695	\$770	\$710	\$811	\$743	\$1,955	\$942	\$1,662	call for quote			
30"x36" (3036)	\$882	\$983	\$893	\$1,036	\$875	\$2,318	\$1,145	\$2,288	call for quote			



**For power & data options and wire management, see pages 112-115.

Slim Square Base Tables (BSS)

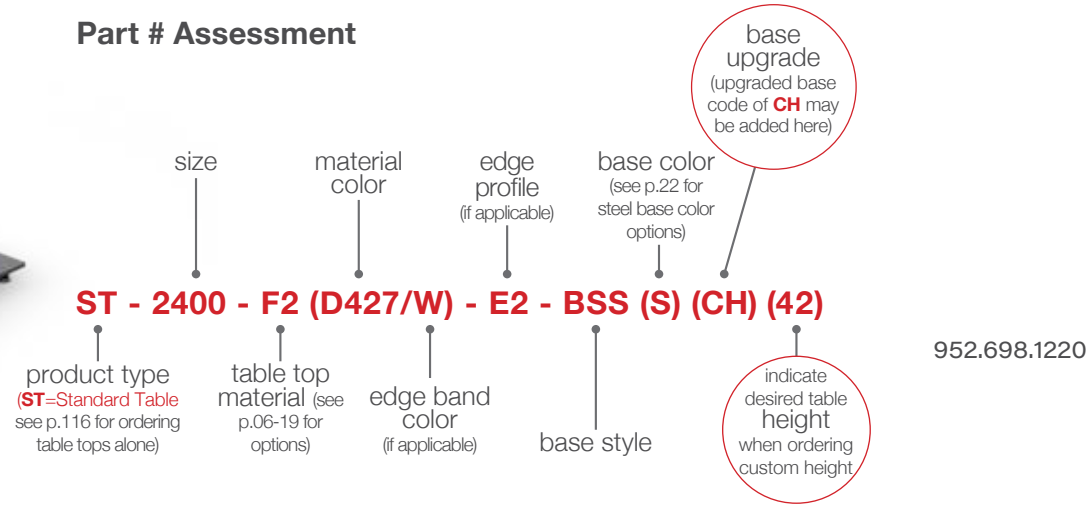



Upgrades and Add-ons



Custom Height CH

To replace standard disk base.....Add \$50 list per table (specify table height in inches)

List Pricing

Size	Table Top Finish and Edge Type										
	F2	F4	F6	F7	F8	F16	F17	F18	F19-F24		
 24" Ø (2400) 30" Ø (3000) 36" Ø (3600) 42" Ø (4200) 48" Ø (4800)	\$646	\$702	\$661	\$736	\$687	\$1,610	\$848	\$1,422	call for quote		
	\$762	\$826	\$803	\$871	\$762	\$2,082	\$1,055	\$2,000	call for quote		
	\$1,036	\$1,208	\$995	\$1,235	\$912	\$2,656	\$1,302	\$2,630	call for quote		
	\$1,125	\$1,335	\$1,249	\$1,530	\$1,039	\$3,922	\$1,594	\$3,484	call for quote		
	\$1,293	\$1,555	\$1,461	\$1,795	\$1,203	\$5,046	\$2,073	\$4,506	call for quote		
 24"x24" (2424) 30"x30" (3030) 36"x36" (3636) 42"x42" (4242)	\$646	\$702	\$657	\$736	\$687	\$1,610	\$848	\$1,422	call for quote		
	\$758	\$826	\$796	\$871	\$762	\$2,082	\$1,055	\$2,000	call for quote		
	\$1,032	\$1,208	\$987	\$1,235	\$912	\$2,656	\$1,302	\$2,630	call for quote		
	\$1,117	\$1,335	\$1,245	\$1,530	\$1,039	\$3,922	\$1,594	\$3,484	call for quote		
 24"x30" (2430) 30"x36" (3036)	\$695	\$770	\$710	\$811	\$743	\$1,955	\$942	\$1,662	call for quote		
	\$882	\$983	\$893	\$1036	\$875	\$2,318	\$1,145	\$2,288	call for quote		



**For power & data options and wire management, see pages 112-115.

Slim Squircle Base Tables (BSQ)

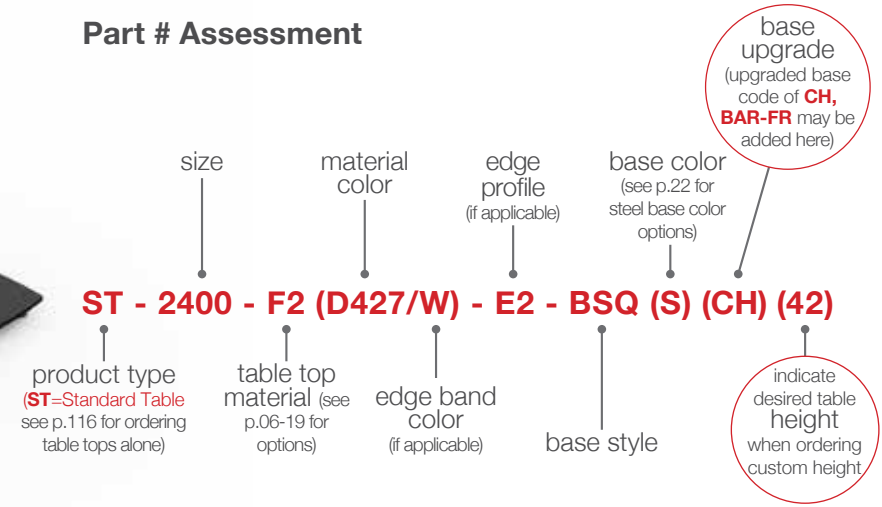

Upgrades and Add-ons



Custom Height CH



To replace standard disk base.....Add \$50 list per table (specify table height in inches)



Bar Height with Foot Ring @ 40.75"h BAR-FR

40.75"h disk base with foot ring to replace standard disk base
24"-30" tables have 14" dia. foot ring. 36"-48" tables have 19" dia. foot ring.Add \$150 list per table

List Pricing

Size	Table Top Finish and Edge Type									
	F2	F4	F6	F7	F8	F16	F17	F18	F19-F24	
 24" Ø (2400) 30" Ø (3000) 36" Ø (3600) 42" Ø (4200) 48" Ø (4800)	\$646	\$702	\$661	\$736	\$687	\$1,610	\$848	\$1,422	call for quote	
	\$762	\$826	\$803	\$871	\$762	\$2,082	\$1,055	\$2,000	call for quote	
	\$1,036	\$1,208	\$995	\$1,235	\$912	\$2,656	\$1,302	\$2,630	call for quote	
	\$1,125	\$1,335	\$1,249	\$1,530	\$1,039	\$3,922	\$1,594	\$3,484	call for quote	
	\$1,293	\$1,555	\$1,461	\$1,795	\$1,203	\$5,046	\$2,073	\$4,506	call for quote	
 24"x24" (2424) 30"x30" (3030) 36"x36" (3636) 42"x42" (4242)	\$646	\$702	\$657	\$736	\$687	\$1,610	\$848	\$1,422	call for quote	
	\$758	\$826	\$796	\$871	\$762	\$2,082	\$1,055	\$2,000	call for quote	
	\$1,032	\$1,208	\$987	\$1,235	\$912	\$2,656	\$1,302	\$2,630	call for quote	
	\$1,117	\$1,335	\$1,245	\$1,530	\$1,039	\$3,922	\$1,594	\$3,484	call for quote	
 24"x30" (2430) 30"x36" (3036)	\$695	\$770	\$710	\$811	\$743	\$1,955	\$942	\$1,662	call for quote	
	\$882	\$983	\$893	\$1,036	\$875	\$2,318	\$1,145	\$2,288	call for quote	



****For power & data options and wire management, see pages 112-115.**

Stainless Steel Square Base Tables (BST)

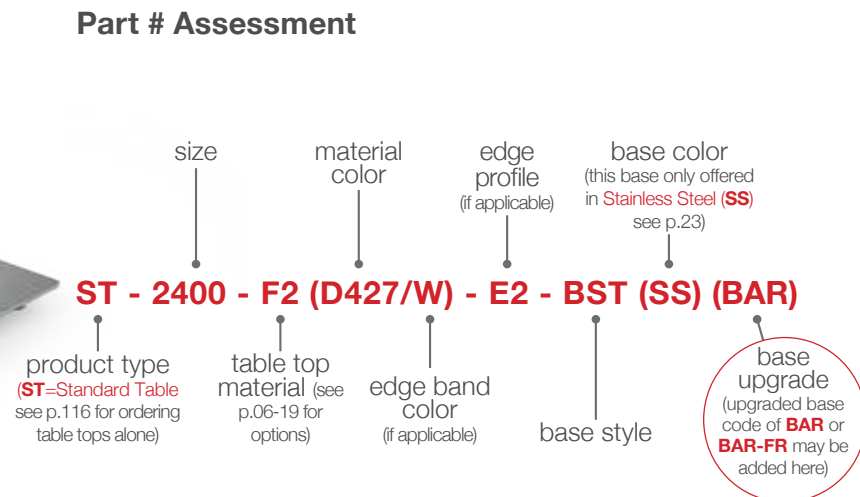

Upgrades and Add-ons



Bar Height @ 40.5”h **BAR**



To replace standard disk base.....Add \$40 list per table



Bar Height with Foot Ring @ 40.5”h **BAR-FR**

40.5”h disk base with 19” dia. foot ring to replace standard disk base.....Add \$215 list per table

List Pricing

Size	Table Top Finish and Edge Type										
	F2	F4	F6	F7	F8	F16	F17	F18	F19-F24		
	Wilsonart® Standard Laminate with Matching Edge Band.....(p.06)	Wilsonart® Standard Laminate on Birch Multiply.....(p.07)	Forbo® Linoleum with BioEdge™ Edgeband.....(p.08)	Forbo® Linoleum on Birch Multiply.....(p.09)	Powder Coated MDF.....(p.10)	Nuzile®.....(p.11)	Solid Hardwood (Butcher Block).....(p.12)	Cambria® Quartz.....(p.13)	(p.14-19)		
	24" Ø (2400)	\$739	\$795	\$754	\$829	\$780	\$1,703	\$941	\$1,515	call for quote	
	30" Ø (3000)	\$855	\$919	\$896	\$964	\$855	\$2,175	\$1,148	\$2,093	call for quote	
	36" Ø (3600)	\$1,129	\$1,301	\$1,088	\$1,328	\$1,005	\$2,749	\$1,395	\$2,723	call for quote	
	42" Ø (4200)	\$1,185	\$1,395	\$1,309	\$1,590	\$1,099	\$3,983	\$1,654	\$3,544	call for quote	
48" Ø (4800)	\$1,367	\$1,630	\$1,536	\$1,870	\$1,277	\$5,121	\$2,950	\$6,719	call for quote		
	24"x24" (2424)	\$739	\$795	\$750	\$829	\$780	\$1,703	\$941	\$1,515	call for quote	
	30"x30" (3030)	\$851	\$919	\$889	\$964	\$855	\$2,175	\$1,148	\$2,093	call for quote	
	36"x36" (3636)	\$1,125	\$1,301	\$1,080	\$1,328	\$1,005	\$2,749	\$1,395	\$2,723	call for quote	
	42"x42" (4242)	\$1,178	\$1,395	\$1,305	\$1,590	\$1,099	\$3,983	\$1,654	\$3,544	call for quote	
	24"x30" (2430)	\$788	\$863	\$803	\$904	\$836	\$2,048	\$1,035	\$1,755	call for quote	
	30"x36" (3036)	\$975	\$1,076	\$986	\$1,129	\$968	\$2,411	\$1,238	\$2,381	call for quote	

Floor Mounted Base Tables (BFM)

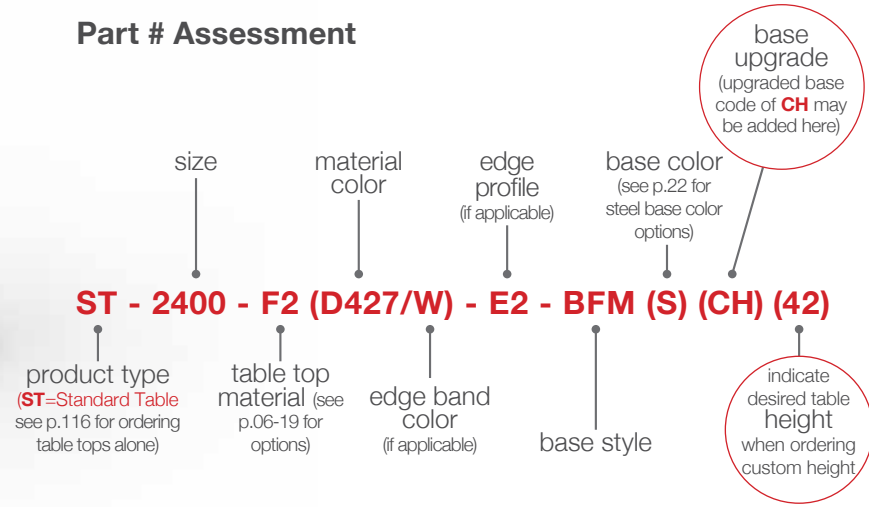

Upgrades and Add-ons



Custom Height CH

To replace standard floor mounted baseAdd \$50 list per table (specify table height in inches)

List Pricing

Size	Table Top Finish and Edge Type										
	F2	F4	F6	F7	F8	F16	F17	F18	F19-F24		
24" Ø (2400)	\$540	\$596	\$555	\$630	\$581	\$1,504	\$742	\$1,316	call for quote		
30" Ø (3000)	\$656	\$720	\$697	\$765	\$656	\$1,976	\$949	\$1,894	call for quote		
36" Ø (3600)	\$930	\$1,102	\$889	\$1,129	\$806	\$2,550	\$1,196	\$2,524	call for quote		
42" Ø (4200)	\$986	\$1,196	\$1,110	\$1,391	\$900	\$3,784	\$1,455	\$3,345	call for quote		
24"x24" (2424)	\$540	\$596	\$551	\$630	\$581	\$1,504	\$742	\$1,316	call for quote		
30"x30" (3030)	\$652	\$720	\$690	\$765	\$656	\$1,976	\$949	\$1,894	call for quote		
36"x36" (3636)	\$926	\$1,102	\$881	\$1,129	\$806	\$2,550	\$1,196	\$2,524	call for quote		
24"x30" (2430)	\$589	\$664	\$604	\$705	\$637	\$1,849	\$836	\$1,556	call for quote		
30"x36" (3036)	\$776	\$877	\$787	\$930	\$769	\$2,212	\$1,039	\$2,182	call for quote		



**For power & data options and wire management, see pages 112-115.

Heavy Round Base Tables (BHR)

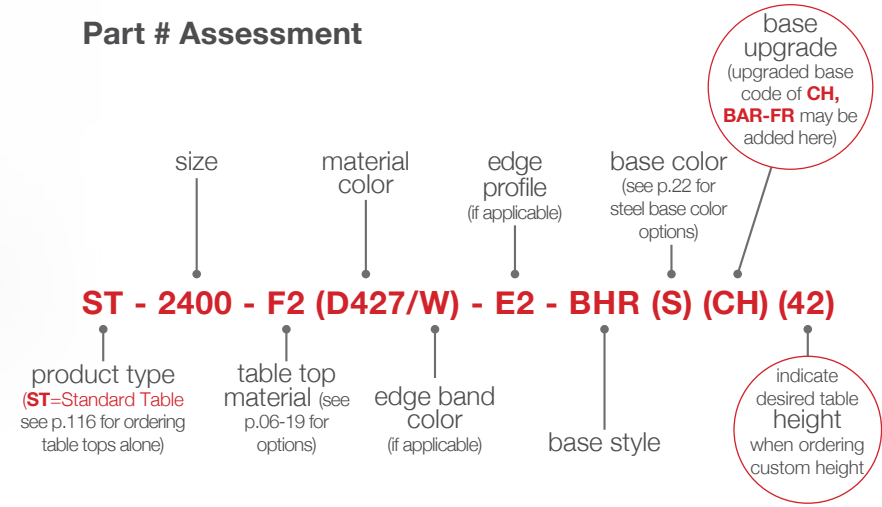

Upgrades and Add-ons



Custom Height CH

To replace standard disk base.....Add \$50 list per table (specify table height in inches)



Bar Height with Foot Ring @ 40.75”h BAR-FR

40.75”h disk base with foot ring to replace standard disk base
 24”-30” tables have 14” dia. foot ring. 36”-48” tables have 19” dia. foot ring.Add \$150 list per table

List Pricing

Size	Table Top Finish and Edge Type										
	F2	F4	F6	F7	F8	F16	F17	F18	F19-F24		
24" Ø (2400)	\$775	\$831	\$790	\$865	\$816	\$1,739	\$977	\$1,551	call for quote		
	\$891	\$955	\$932	\$1,000	\$891	\$2,211	\$1,184	\$2,129	call for quote		
	\$1,165	\$1,337	\$1,124	\$1,364	\$1,041	\$2,785	\$1,431	\$2,759	call for quote		
	\$1,265	\$1,475	\$1,389	\$1,670	\$1,179	\$4,063	\$1,734	\$3,624	call for quote		
30" Ø (3000)	\$1,466	\$1,728	\$1,634	\$1,968	\$1,376	\$5,219	\$2,246	\$4,679	call for quote		
	\$775	\$831	\$786	\$865	\$816	\$1,739	\$977	\$1,551	call for quote		
	\$887	\$955	\$925	\$1,000	\$891	\$2,211	\$1,184	\$2,129	call for quote		
	\$1,161	\$1,337	\$1,116	\$1,364	\$1,041	\$2,785	\$1,431	\$2,759	call for quote		
36" Ø (3600)	\$1,258	\$1,475	\$1,385	\$1,670	\$1,179	\$4,063	\$1,734	\$3,624	call for quote		
	\$1,458	\$1,728	\$1,623	\$1,968	\$1,376	\$5,219	\$2,246	\$4,679	call for quote		
	\$824	\$899	\$839	\$940	\$872	\$2,084	\$1,071	\$1,791	call for quote		
	\$1,011	\$1,112	\$1,022	\$1,165	\$1,004	\$2,447	\$1,274	\$2,417	call for quote		



**For power & data options and wire management, see pages 112-115.

Trumpet Base Tables (BR)

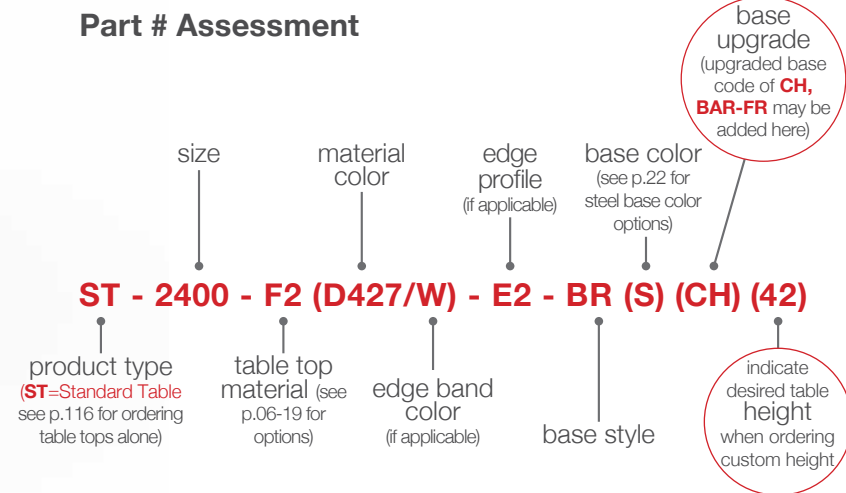

Upgrades and Add-ons



Custom Height **CH**

To replace standard disk base.....Add \$50 list per table (specify table height in inches)



Bar Height with Foot Ring @ 40.75”h **BAR-FR**

40.75”h disk base with foot ring to replace standard disk base
 24”-30” tables have 14” dia. foot ring. 36”-48” tables have 19” dia. foot ring.Add \$150 list per table

List Pricing

Size	Table Top Finish and Edge Type										
	F2	F4	F6	F7	F8	F16	F17	F18	F19-F24		
 24" Ø (2400) 30" Ø (3000) 36" Ø (3600) 42" Ø (4200)	\$675	\$732	\$690	\$765	\$717	\$1,639	\$878	\$1,452	call for quote		
	\$792	\$855	\$833	\$900	\$792	\$2,112	\$1,084	\$2,029	call for quote		
	\$1,065	\$1,238	\$1,024	\$1,264	\$942	\$2,685	\$1,332	\$2,659	call for quote		
	\$1,162	\$1,372	\$1,286	\$1,567	\$1,076	\$3,960	\$1,631	\$3,521	call for quote		
 24"x24" (2424) 30"x30" (3030) 36"x36" (3636) 42"x42" (4242)	\$675	\$732	\$687	\$765	\$717	\$1,639	\$878	\$1,452	call for quote		
	\$788	\$855	\$825	\$900	\$792	\$2,112	\$1,084	\$2,029	call for quote		
	\$1,062	\$1,238	\$1,017	\$1,264	\$942	\$2,685	\$1,332	\$2,659	call for quote		
	\$1,155	\$1,372	\$1,282	\$1,567	\$1,076	\$3,960	\$1,631	\$3,521	call for quote		
 24"x30" (2430) 30"x36" (3036)	\$724	\$799	\$739	\$840	\$773	\$1,984	\$972	\$1,692	call for quote		
	\$912	\$1,013	\$923	\$1,065	\$904	\$2,348	\$1,174	\$2,318	call for quote		



**For power & data options and wire management, see pages 112-115.

Picture Frame Base Tables (BPF)



Part # Assessment

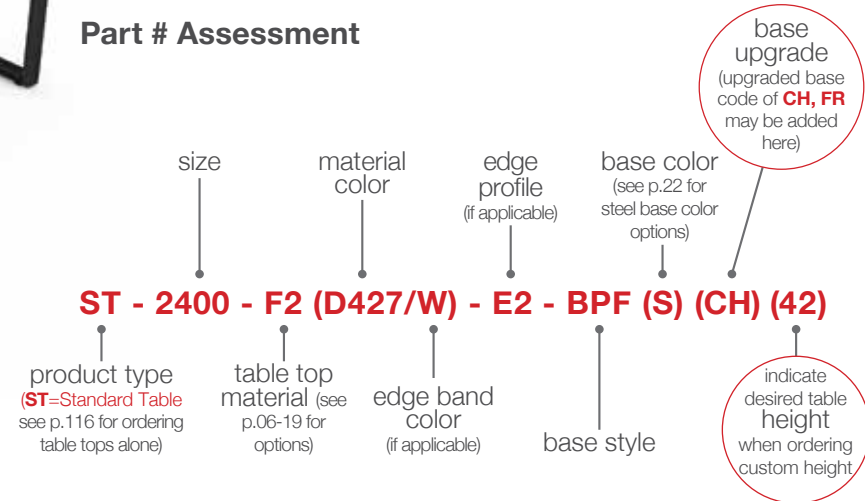

Upgrades and Add-ons



Custom Height **CH**

To replace standard base Add \$110 list per table (specify table ht. in inches; max. ht. for base=40.375")

List Pricing

Size	F2	F4	F6	F7	F8	F17	F18	F19-F24
18"x48" (1848)	\$854	\$955	\$854	\$989	\$854	\$1,064	\$2,159	call for quote
18"x60" (1860)	\$933	\$1,060	\$933	\$1,101	\$933	\$1,191	\$2,564	call for quote
18"x72" (1872)	\$1,011	\$1,165	\$1,011	\$1,214	\$1,011	\$1,323	\$2,969	call for quote
22"x48" (2248)	\$945	\$1,069	\$945	\$1,110	\$945	\$1,200	\$2,539	call for quote
22"x60" (2260)	\$1,039	\$1,196	\$1,039	\$1,245	\$1,039	\$1,357	\$3,034	call for quote
22"x72" (2272)	\$1,136	\$1,324	\$1,136	\$1,384	\$1,136	\$1,519	\$3,529	call for quote
28"x48" (2848)	\$1,073	\$1,230	\$1,073	\$1,283	\$1,073	\$1,395	\$3,101	call for quote
28"x60" (2860)	\$1,193	\$1,391	\$1,193	\$1,455	\$1,193	\$1,598	\$3,731	call for quote
28"x72" (2872)	\$1,316	\$1,553	\$1,316	\$1,631	\$1,316	\$1,804	\$4,361	call for quote
28"x84" (2884)	\$1,440	\$1,714	\$1,440	\$1,808	\$1,440	\$2,006	\$4,991	call for quote
28"x90" (2890)	\$1,500	\$1,796	\$1,500	\$1,894	\$1,500	\$2,108	\$5,306	call for quote



**For power & data options and wire management, see pages 112-115.

Angled Base Tables (BAC)



Part # Assessment

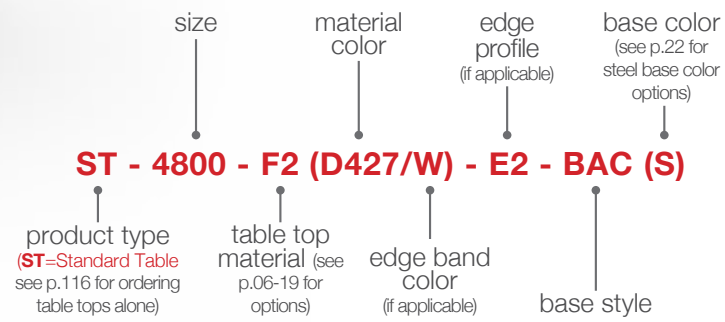

Sizes and Leg Configurations

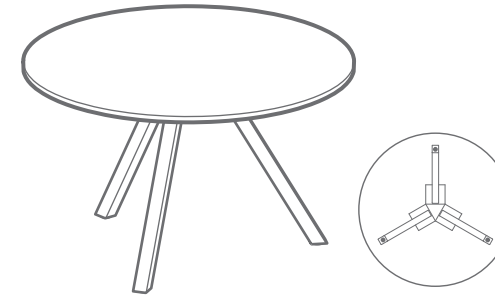

48" Diameter with 3 Legs **4800**

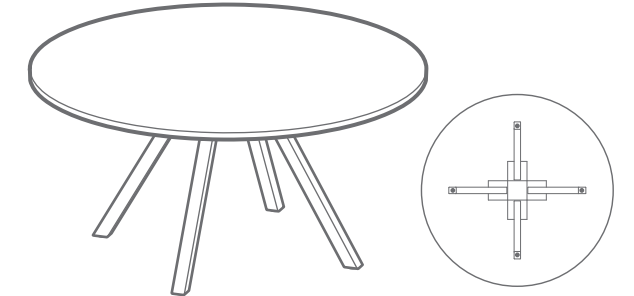

60" Diameter with 4 Legs **6000**



42" x 60" with A-Line Legs **4260A**



42" x 60" with Splayed Legs **4260S**

List Pricing

Size	Table Top Finish and Edge Type							
	F2	F4	F6	F7	F8	F16	F17	
Wilsonart® Standard Laminate with Matching Edge Band (p.06)								
Wilsonart® Standard Laminate on Birch Multiply (p.07)								
Forbo® Linoleum with BioEdge™ Edgeband (p.08)								
Forbo® Linoleum on Birch Multiply (p.09)								
Powder Coated MDF (p.10)								
Nuzile® (p.11)								
Solid Hardwood (Butcher Block) (p.12)								
48" Ø (4800)	\$1,141	\$1,403	\$1,309	\$1,643	\$1,051	\$4,894	\$1,977	
60" Ø (6000)	\$1,732	\$2,081	\$1,893	\$2,219	N/A	N/A	\$2,939	
42"x60" (4260A) A-Line	\$1,520	\$1,643	\$1,583	\$1,737	\$1,520	\$5,457	\$2,701	
42"x60" (4260S) Splayed	\$1,520	\$1,643	\$1,583	\$1,737	\$1,520	\$5,457	\$2,701	



**For power & data options and wire management, see pages 112-115.

Ornate Base Tables (BO)



Part # Assessment

size: 2400
 material color: F2 (D427/W)
 edge profile (if applicable): E2
 base color (this cast iron base only offered in Black Wrinkle (BW) see p.23): BO (BW)

product type (ST=Standard Table see p.116 for ordering table tops alone): ST
 table top material (see p.06-19 for options): F2 (D427/W)
 edge band color (if applicable): E2
 base style: BO (BW)

ST - 2400 - F2 (D427/W) - E2 - BO (BW)

Cantilevered Base Tables (BC)



Part # Assessment

size: 2448
 material color: F2 (D427/W)
 edge profile (if applicable): E2
 base color (see p.22 for steel base color options): BC (S)

product type (ST=Standard Table see p.116 for ordering table tops alone): ST
 table top material (see p.06-19 for options): F2 (D427/W)
 edge band color (if applicable): E2
 base style: BC (S)

ST - 2448 - F2 (D427/W) - E2 - BC (S)

List Pricing

Size	Table Top Finish and Edge Type									
	F2	F4	F6	F7	F8	F16	F17	F18	F19-F24	
24" Ø (2400)	\$754	\$810	\$769	\$844	\$795	\$1,717	\$956	\$1,530	call for quote	
30" Ø (3000)	\$946	\$1,010	\$988	\$1,055	\$946	\$2,266	\$1,239	\$2,184	call for quote	
36" Ø (3600)	\$1,309	\$1,482	\$1,268	\$1,508	\$1,185	\$2,929	\$1,575	\$2,903	call for quote	
42" Ø (4200)	\$1,365	\$1,575	\$1,489	\$1,770	\$1,279	\$4,163	\$1,834	\$3,724	call for quote	
48" Ø (4800)	\$1,458	\$1,721	\$1,627	\$1,961	\$1,368	\$5,212	\$2,238	\$4,672	call for quote	
24"x24" (2424)	\$754	\$810	\$765	\$844	\$795	\$1,717	\$956	\$1,530	call for quote	
30"x30" (3030)	\$943	\$1,010	\$980	\$1,055	\$946	\$2,266	\$1,239	\$2,184	call for quote	
36"x36" (3636)	\$1,305	\$1,482	\$1,260	\$1,508	\$1,185	\$2,929	\$1,575	\$2,903	call for quote	
42"x42" (4242)	\$1,358	\$1,575	\$1,485	\$1,770	\$1,279	\$4,163	\$1,834	\$3,724	call for quote	
48"x48" (4848)	\$1,451	\$1,721	\$1,616	\$1,961	\$1,368	\$5,212	\$2,238	\$4,672	call for quote	

List Pricing

Size	Table Top Finish and Edge Type									
	F2	F4	F6	F7	F8	F16	F17	F18	F19-F24	
24"x48" (2448)	\$633	\$757	\$660	\$825	\$675	\$2,220	\$1,027	\$2,463	call for quote	
24"x60" (2460)	\$836	\$922	\$1,005	\$945	\$806	\$2,670	\$1,207	\$2,981	call for quote	
24"x72" (2472)	\$961	\$1,167	\$957	\$1,239	\$935	\$3,170	\$1,434	\$3,552	call for quote	
30"x48" (3048)	\$750	\$900	\$780	\$975	\$750	\$2,655	\$1,237	\$2,988	call for quote	
30"x60" (3060)	\$937	\$1,023	\$982	\$1,091	\$825	\$3,206	\$1,462	\$3,637	call for quote	
30"x72" (3072)	\$1,032	\$1,572	\$1,115	\$1,775	\$1,066	\$3,815	\$1,741	\$4,340	call for quote	

Collaboration Tables



Collaboration Base Styles



A-Frame Base (BAFC)
p.73



Picture Frame Base (BPFC)
p.74

A-Frame Base Tables (BAFC)



Part # Assessment

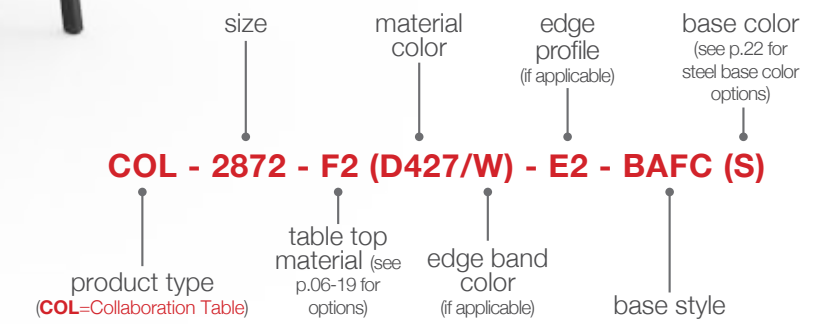

Parsons Base (BPRC)
p.75



H Base (BHC)
p.76

List Pricing

Size	Table Top Finish and Edge Type	F2	F4	F6	F7	F8	F16	F17	F18	F19-F24
28"x72" (2872)	Wilsonart® Standard Laminate with Matching Edge Band	\$2,328	\$2,868	\$2,410	\$3,070	\$2,362	\$5,110	\$3,037	\$5,635	call for quote

(Additional finishes and edge types are listed in the header but not priced in this view)

Please Note: Base height is only offered at 38.5" h.



****For power & data options and wire management, see pages 112-115.**

Picture Frame Base Tables (BPFC)



Part # Assessment

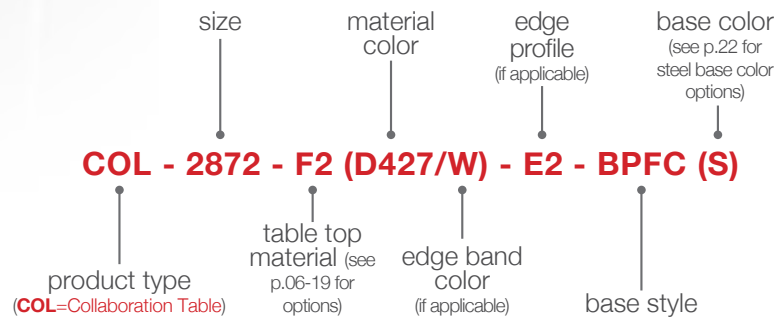

Parsons Base Tables (BPRC)



Part # Assessment

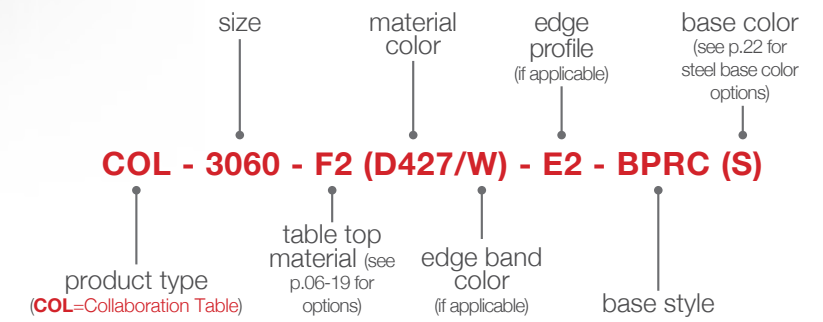

List Pricing

Size	Table Top Finish and Edge Type							
	F2	F4	F6	F7	F8	F17		
28"x72" (2872)	\$1,426	\$1,966	\$1,508	\$2,168	\$1,460	\$2,135		
34"x72" (3472)	\$1,644	\$1,760	\$1,707	\$1,854	\$1,644	\$2,791		
40"x72" (4072)	\$1,824	\$1,963	\$1,899	\$2,072	\$1,824	\$3,174		
28"x84" (2884)	\$1,922	\$2,034	\$1,982	\$2,124	\$1,922	\$3,024		
28"x90" (2890)	\$1,982	\$2,102	\$2,049	\$2,199	\$1,982	\$3,163		
34"x84" (3484)	\$2,128	\$2,263	\$2,203	\$2,372	\$2,128	\$3,467		
34"x90" (3490)	\$2,203	\$2,350	\$2,282	\$2,466	\$2,203	\$3,636		
40"x84" (4084)	\$2,335	\$2,496	\$2,421	\$2,624	\$2,335	\$3,910		
40"x90" (4090)	\$2,421	\$2,594	\$2,515	\$2,733	\$2,421	\$4,109		
46"x90" (4690)	\$2,643	\$2,838	\$2,748	\$2,995	\$2,643	\$4,582		

Please Note: Base height is 40.375" h.



**For power & data options and wire management, see pages 112-115.

List Pricing

Size	Table Top Finish and Edge Type							
	F2	F4	F6	F7	F8	F17		
30"x60" (3060)	\$1,730	\$1,816	\$1,775	\$1,884	\$1,618	\$2,255		
30"x72" (3072)	\$1,802	\$2,342	\$1,884	\$2,544	\$1,835	\$2,510		
36"x60" (3660)	\$1,878	\$1,983	\$1,934	\$2,065	\$1,878	\$2,890		
36"x72" (3672)	\$2,061	\$2,185	\$2,129	\$2,283	\$2,061	\$3,276		
42"x60" (4260)	\$2,002	\$2,122	\$2,069	\$2,219	\$2,002	\$3,183		
42"x72" (4272)	\$2,204	\$2,350	\$2,282	\$2,462	\$2,204	\$3,621		
48"x60" (4860)	\$2,157	\$2,296	\$2,232	\$2,405	\$2,157	\$3,507		
48"x72" (4872)	\$2,391	\$2,556	\$2,481	\$2,688	\$2,391	\$4,011		

Please Note: Base style offered at 27.75" h or 40.375" h. For 27.75" h table, subtract 10% from list pricing.



**For power & data options and wire management, see pages 112-115.

H-Frame Base Tables (BHC)



Part # Assessment

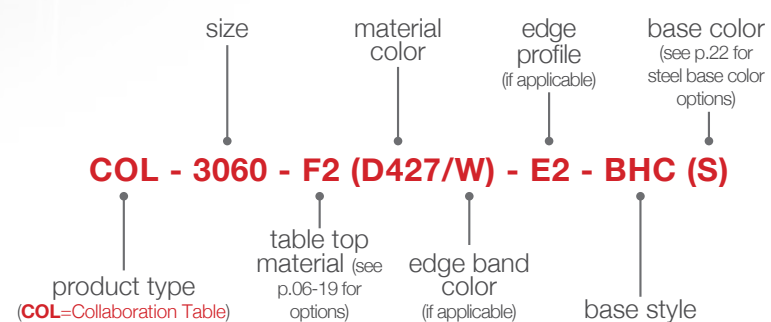

List Pricing

Size	Table Top Finish and Edge Type						
	F2	F4	F6	F7	F8	F17	
	Wilsonart® Standard Laminate with Matching Edge Band	Wilsonart® Standard Laminate with Multiply	Forbo® Linoleum on Birch Edgeband	Forbo® Linoleum with BioEdge™	Forbo® Linoleum on Birch	Powder Coated MDF	Solid Hardwood (Butcher Block)
	(p.06)	(p.07)	(p.08)	(p.09)	(p.10)	(p.12)	
30"x60" (3060)	\$1,385	\$1,471	\$1,430	\$1,538	\$1,272	\$1,910	
30"x72" (3072)	\$1,426	\$1,966	\$1,508	\$2,168	\$1,460	\$2,135	
36"x60" (3660)	\$1,516	\$1,621	\$1,572	\$1,703	\$1,516	\$2,528	
36"x72" (3672)	\$1,673	\$1,797	\$1,741	\$1,895	\$1,673	\$2,888	
42"x60" (4260)	\$1,745	\$1,865	\$1,813	\$1,963	\$1,745	\$2,926	
42"x72" (4272)	\$1,929	\$2,075	\$2,008	\$2,188	\$1,929	\$3,346	
42"x84" (4284)	\$2,113	\$2,281	\$2,206	\$2,416	\$2,113	\$3,766	
48"x72" (4872)	\$2,086	\$2,251	\$2,176	\$2,383	\$2,086	\$3,706	
42"x96" (4296)	\$2,670	\$2,865	\$2,775	\$3,015	\$2,670	\$4,560	
48"x96" (4896)	\$2,880	\$3,102	\$3,000	\$3,278	\$2,880	\$5,040	

Please Note: Base style offered at 27.75"h or 40.375"h. For 27.75"h table, subtract 10% from list pricing.



****For power & data options and wire management, see pages 112-115.**

Occasional Tables



Occasional Base Styles



Cubic Base (BCU)
p.83



C-Base (BCE)
p.83

Cubic Base Tables (X)



Part # Assessment

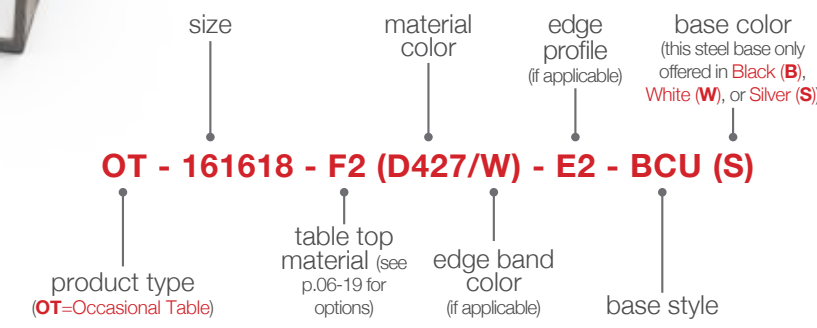

Laptop Base (BLT)
p.83



Picture Frame Base (BPFCO)
p.84

List Pricing

Size	Table Top Finish and Edge Type				
	F2	F4	F7	F8	F17
	<small> F2: Wisohart® Standard Laminate with Matching Edge Band (3/4" thick)(p.06) F4: Wisohart® Standard Laminate on Birch Multiply (3/4" thick)(p.07) F7: Forbo® Linoleum on Birch Multiply (3/4" thick)(p.09) F8: Powder Coated MDF (3/4" thick)(p.10) F17: Solid Hardwood (Butcher Block) (3/4" thick)(p.12) </small>				
16"x16"x18"h (161618)	\$452	\$475	\$489	\$468	\$537
18"x18"x18"h (181818)	\$480	\$523	\$531	\$503	\$590
16"x30"x24"h (163024)	\$526	\$591	\$614	\$572	\$700
30"x30"x14"h (303014)	\$987	\$1,101	\$1,149	\$1,078	\$1,204



****For power & data options and wire management, see pages 112-115.**

C-Base Tables (BCE)

Laptop Base Tables (BLT)



Part # Assessment

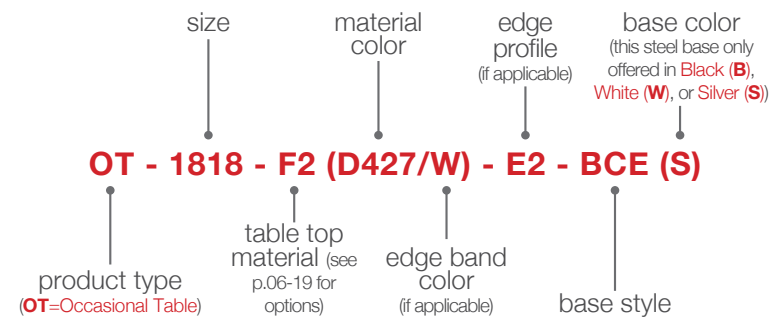

Part # Assessment

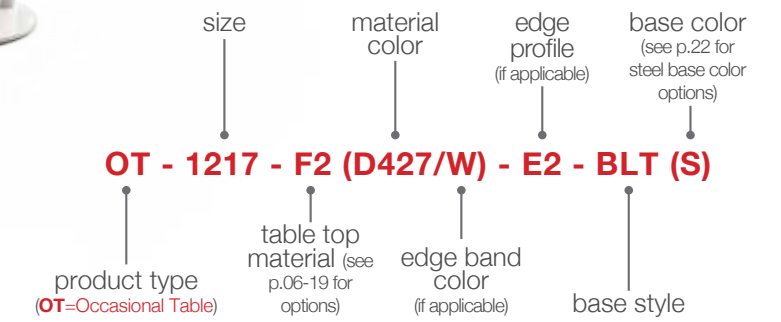

List Pricing

Size	Table Top Finish and Edge Type				
	F2	F4	F7	F8	F17
	Wilsonart® Standard Laminate with Matching Edge Band (3/4" thick) (p.06)				
	Wilsonart® Standard Laminate on Birch Multiply (3/4" thick) (p.07)				
	Forbo® Linoleum on Birch Multiply (3/4" thick) (p.09)				
	Powder Coated MDF (3/4" thick) (p.10)				
	Solid Hardwood (Butcher Block) (3/4" thick) (p.12)				
18"x18"x24"h (1818)	\$470	\$513	\$521	\$492	\$579
22"x22"x24"h (2222)	\$533	\$601	\$620	\$571	\$699

List Pricing

Size	Table Top Finish and Edge Type				
	F2	F4	F7	F8	F17
	Wilsonart® Standard Laminate with Matching Edge Band (3/4" thick) (p.06)				
	Wilsonart® Standard Laminate on Birch Multiply (3/4" thick) (p.07)				
	Forbo® Linoleum on Birch Multiply (3/4" thick) (p.09)				
	Powder Coated MDF (3/4" thick) (p.10)				
	Solid Hardwood (Butcher Block) (3/4" thick) (p.12)				
14" Ø x26"h (1300)	\$262	\$288	\$293	\$276	\$328
18" Ø x26"h (1800)	\$299	\$343	\$351	\$322	\$409
12"x17"x26"h (1217)	\$262	\$288	\$293	\$276	\$328

Please Note: This occasional base style is offered at 25.25"h.

Picture Frame Base Tables (BPFCO)



Part # Assessment

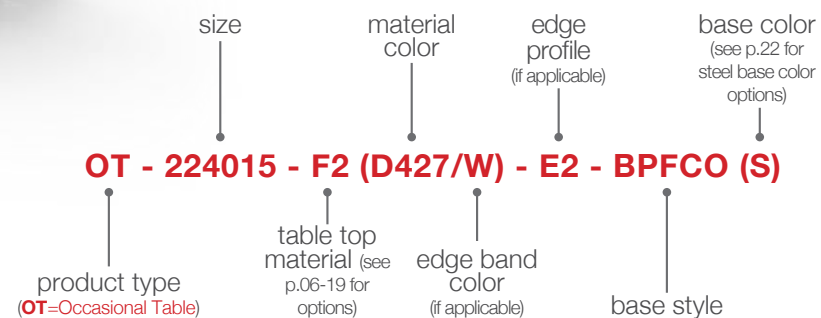

List Pricing

Size	Table Top Finish and Edge Type									
	F2	F4	F6	F7	F8	F17	F18			
	Wilsonart® Standard Laminate with Matching Edge Band	Wilsonart® Standard Laminate with Multiply	Forbo® Linoleum on Birch Edgeband	Forbo® Linoleum with BioEdge™ Multiply	Powder Coated MDF	Solid Hardwood (Butcher Block)	Cambria® Quartz			
	(p.06)	(p.07)	(p.08)	(p.09)	(p.10)	(p.12)	(p.13)			
22.25"x40"x15"h (224015)	\$1,058	\$1,182	\$1,084	\$1,249	\$1,099	\$1,452	\$2,888			

Please Note: This occasional base style is offered at 14"h.



****For power & data options and wire management, see pages 112-115.**

Conference Tables

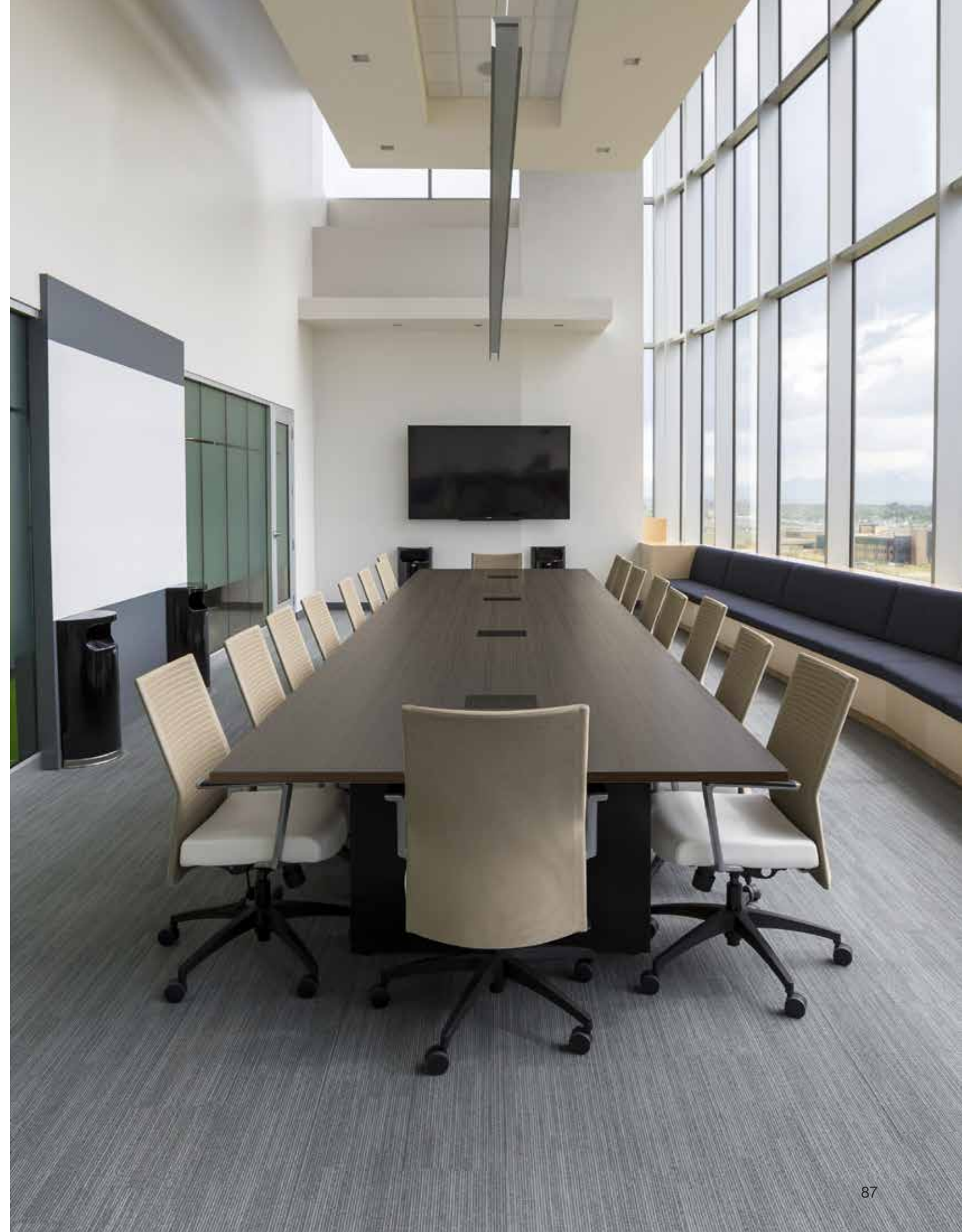

Conference Table Base Styles



Toob Base (BTT)
p.89



Ingot Base (BII)
p.90



Arch Base (BAA)
p.91



XL Angled Base (BAX)
p.92



Drum Base (BDR)
p.93



Mono Base (BF)
p.94

Toob Base Tables (BTT)



Part # Assessment

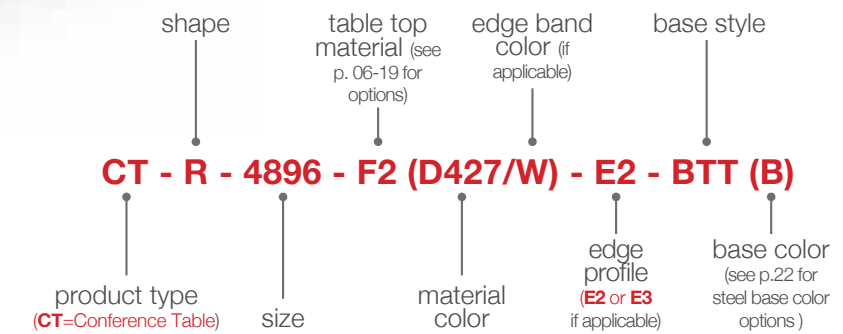

List Pricing

Shape	Size	Table Top Finish and Edge Type							
		F2	F4	F6	F7	F17	F18	F19-F24	
rectangle (R)	48"x96" (4896)	\$3,201	\$3,321	\$3,321	\$3,681	\$5,121	\$9,201	call for quote	
	48"x120" (48120)	\$3,859	\$4,009	\$4,009	\$4,459	\$6,259	\$11,359	call for quote	
	48"x144" (48144)	\$4,429	\$4,609	\$4,609	\$5,149	\$7,309	\$13,429	call for quote	
racetrack (T)	48"x96" (4896)	\$3,561	\$3,681	\$3,681	\$4,041	\$5,481	\$9,561	call for quote	
	48"x120" (48120)	\$4,309	\$4,459	\$4,459	\$4,909	\$6,709	\$11,809	call for quote	
convex (C)	48"x96" (4896)	\$3,561	\$3,681	\$3,681	\$4,041	\$5,481	\$9,561	call for quote	
	48"x120" (48120)	\$4,309	\$4,459	\$4,459	\$4,909	\$6,709	\$11,809	call for quote	
boat (B)	48"x96" (4896)	\$3,561	\$3,681	\$3,681	\$4,041	\$5,481	\$9,561	call for quote	
	48"x120" (48120)	\$4,309	\$4,459	\$4,459	\$4,909	\$6,709	\$11,809	call for quote	
	54"x144" (54144)	\$5,464	\$5,667	\$5,667	\$6,274	\$8,704	\$15,589	call for quote	

Please Note: Standard table height is 29". 96" tables have two bases; 120" and 144" tables have three bases.



****For power & data options and wire management, see pages 112-115.**

Ingot Base Tables (BII)



Part # Assessment

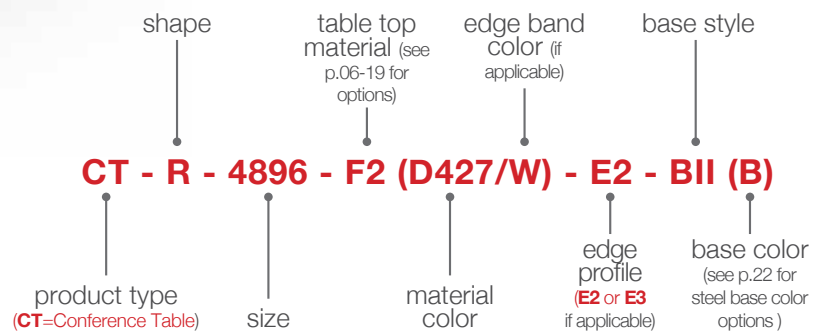

Arch Base Tables (BAA)



Part # Assessment

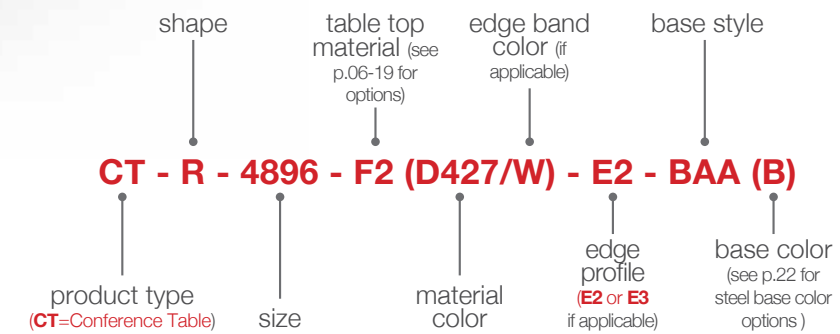

List Pricing

Shape	Size	Table Top Finish and Edge Type								
		F2	F4	F6	F7	F17	F18	F19-F24		
rectangle (R)	48"x96" (4896)	\$3,479	\$3,599	\$3,599	\$3,959	\$5,399	\$9,479	call for quote		
	48"x120" (48120)	\$4,486	\$4,636	\$4,636	\$5,086	\$6,886	\$11,986	call for quote		
	48"x144" (48144)	\$5,056	\$5,236	\$5,236	\$5,776	\$7,936	\$14,056	call for quote		
racetrack (T)	48"x96" (4896)	\$3,839	\$3,959	\$3,959	\$4,319	\$5,759	\$9,839	call for quote		
	48"x120" (48120)	\$4,936	\$5,086	\$5,086	\$5,536	\$7,336	\$12,436	call for quote		
convex (C)	48"x96" (4896)	\$3,839	\$3,959	\$3,959	\$4,319	\$5,759	\$9,839	call for quote		
	48"x120" (48120)	\$4,936	\$5,086	\$5,086	\$5,536	\$7,336	\$12,436	call for quote		
boat (B)	54"x144" (54144)	\$6,091	\$6,294	\$6,294	\$6,901	\$9,331	\$16,216	call for quote		

Please Note: Standard table height is 29". 96" tables have two bases; 120" and 144" tables have three bases.

List Pricing

Shape	Size	Table Top Finish and Edge Type								
		F2	F4	F6	F7	F17	F18	F19-F24		
rectangle (R)	48"x96" (4896)	\$3,224	\$3,344	\$3,344	\$3,704	\$5,144	\$9,224	call for quote		
	48"x120" (48120)	\$4,104	\$4,254	\$4,254	\$4,704	\$6,504	\$11,604	call for quote		
	48"x144" (48144)	\$4,674	\$4,854	\$4,854	\$5,394	\$7,554	\$13,674	call for quote		
racetrack (T)	48"x96" (4896)	\$3,584	\$3,704	\$3,704	\$4,064	\$5,504	\$9,584	call for quote		
	48"x120" (48120)	\$4,554	\$4,704	\$4,704	\$5,154	\$6,954	\$12,054	call for quote		
convex (C)	48"x96" (4896)	\$3,584	\$3,704	\$3,704	\$4,064	\$5,504	\$9,584	call for quote		
	48"x120" (48120)	\$4,554	\$4,704	\$4,704	\$5,154	\$6,954	\$12,054	call for quote		
boat (B)	54"x144" (54144)	\$6,091	\$6,294	\$6,294	\$6,901	\$9,331	\$16,216	call for quote		

Please Note: Standard table height is 29". 96" tables have two bases; 120" and 144" tables have three bases.



**For power & data options and wire management, see pages 112-115.



**For power & data options and wire management, see pages 112-115.

XL Angled Base Tables (BAX)



Part # Assessment

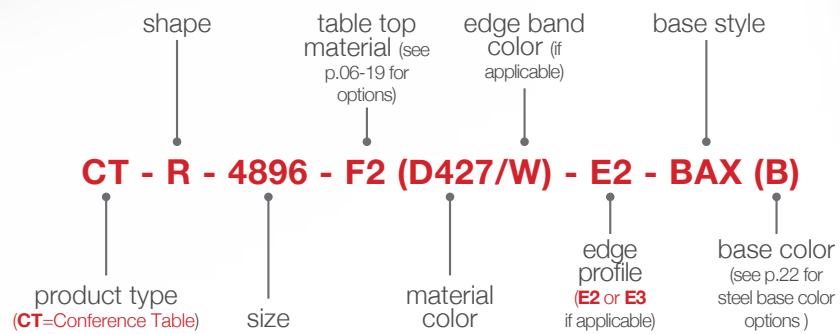

Drum Base Tables (BDR)



Part # Assessment

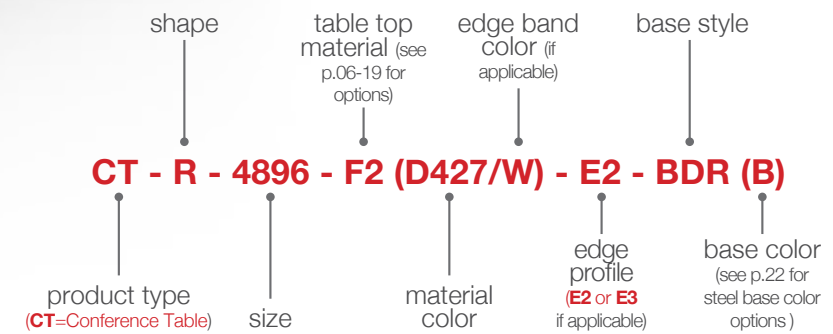

List Pricing

			Size	Table Top Finish and Edge Type				
				F2	F4	F6	F7	F17
rectangle (R) racetrack (T) convex (C)	48"x96" (4896)	\$3,364	\$3,484	\$3,484	\$3,844	\$5,284		
	48"x120" (48120)	\$3,934	\$4,084	\$4,084	\$4,534	\$6,334		
	48"x144" (48144)	\$4,504	\$4,684	\$4,684	\$5,224	\$7,384		
boat (B)	48"x96" (4896)	\$3,724	\$3,844	\$3,844	\$4,204	\$5,644		
	48"x120" (48120)	\$4,384	\$4,534	\$4,534	\$4,984	\$6,784		
	54"x144" (54144)	\$5,539	\$5,742	\$5,742	\$6,349	\$8,779		

Please Note: Standard table height is 29". 96" tables have four bases; 120" and 144" tables have six bases.

List Pricing

			Size	Table Top Finish and Edge Type						
				F2	F4	F6	F7	F17	F18	F19-F24
rectangle (R) racetrack (T) convex (C)	48"x96" (4896)	\$6,898	\$7,018	\$7,018	\$7,378	\$8,818	\$12,898	call for quote		
	48"x120" (48120)	\$9,616	\$9,766	\$9,766	\$10,216	\$12,016	\$17,116	call for quote		
	48"x144" (48144)	\$10,186	\$10,366	\$10,366	\$10,906	\$13,066	\$19,186	call for quote		
boat (B)	48"x96" (4896)	\$7,258	\$7,378	\$7,378	\$7,738	\$9,178	\$13,258	call for quote		
	48"x120" (48120)	\$10,066	\$10,216	\$10,216	\$10,666	\$12,466	\$17,566	call for quote		
	54"x144" (54144)	\$11,221	\$11,423	\$11,423	\$12,031	\$14,461	\$21,346	call for quote		

Please Note: Standard table height is 29". 96" and 120" tables have two bases; 144" tables have three bases.



****For power & data options and wire management, see pages 112-115.**



****For power & data options and wire management, see pages 112-115.**

Mono Base Tables (BF)

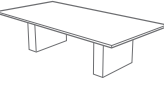
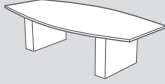

List Pricing

Shape	Size	Table Top Finish and Edge Type							
		F2	F4	F6	F7	F17	F18	F19-F24	
 rectangle (R)	48"x120" (48120)	\$9,863	\$10,013	\$10,013	\$10,463	\$12,263	\$17,363	call for quote	
	48"x144" (48144)	\$10,523	\$10,703	\$10,703	\$11,243	\$13,403	\$19,343	call for quote	
	48"x168" (48168)	\$12,589	\$12,799	\$12,799	\$13,429	\$15,949	\$22,879	call for quote	
	48"x192" (48192)	\$13,249	\$13,489	\$13,489	\$14,209	\$17,089	\$25,009	call for quote	
	48"x216" (48216)	\$13,909	\$14,179	\$14,179	\$14,989	\$18,229	\$27,139	call for quote	
	48"x240" (48240)	\$13,163	\$13,463	\$13,463	\$14,363	\$17,963	\$27,863	call for quote	
 boat (B)	48"x120" (48120)	\$9,863	\$10,013	\$10,013	\$10,463	\$12,263	\$17,363	call for quote	
	54"x144" (54144)	\$13,031	\$13,234	\$13,234	\$13,841	\$16,271	\$22,954	call for quote	
	54"x168" (54168)	\$13,875	\$14,111	\$14,111	\$14,820	\$17,655	\$25,451	call for quote	
	54"x192" (54192)	\$14,719	\$14,989	\$14,989	\$15,799	\$19,039	\$27,949	call for quote	
	60"x216" (60216)	\$16,406	\$16,744	\$16,744	\$17,756	\$21,806	\$32,944	call for quote	
	60"x240" (60240)	\$17,344	\$17,719	\$17,719	\$18,844	\$23,344	\$35,719	call for quote	

Understructure

Each Mono Base is connected with a 100% recycled steel "keel" that serves as a wire manager while providing stability to the table.

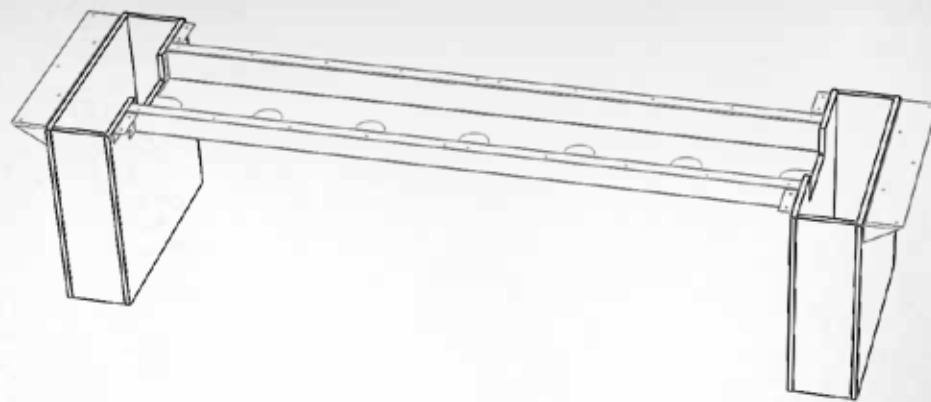

Base Color Selection

Choose from these four standard Wilsonart® styles. Custom styles available upon request, contact Baltix.

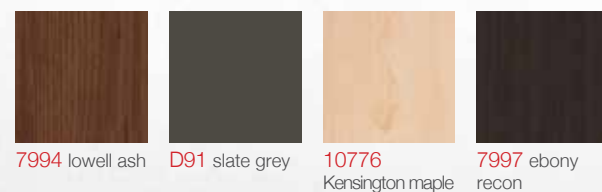

Please Note:

Standard table height is 29". 120" and 144" tables have two bases; 168"-240" tables have three bases; 264" and 288" tables have four bases.

Part # Assessment

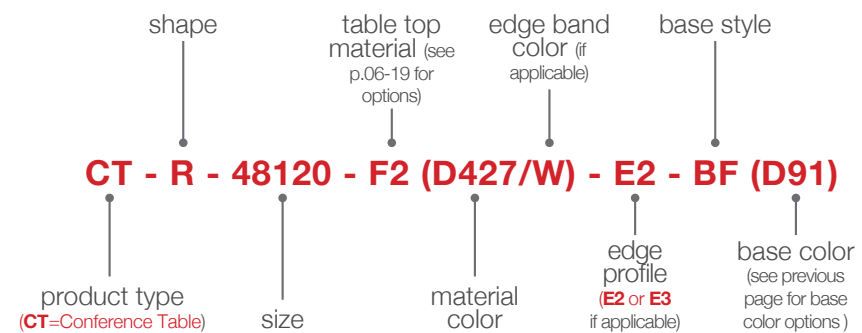

**For power & data options and wire management, see pages 112-115.

Greenlites™ Lightweight Tables

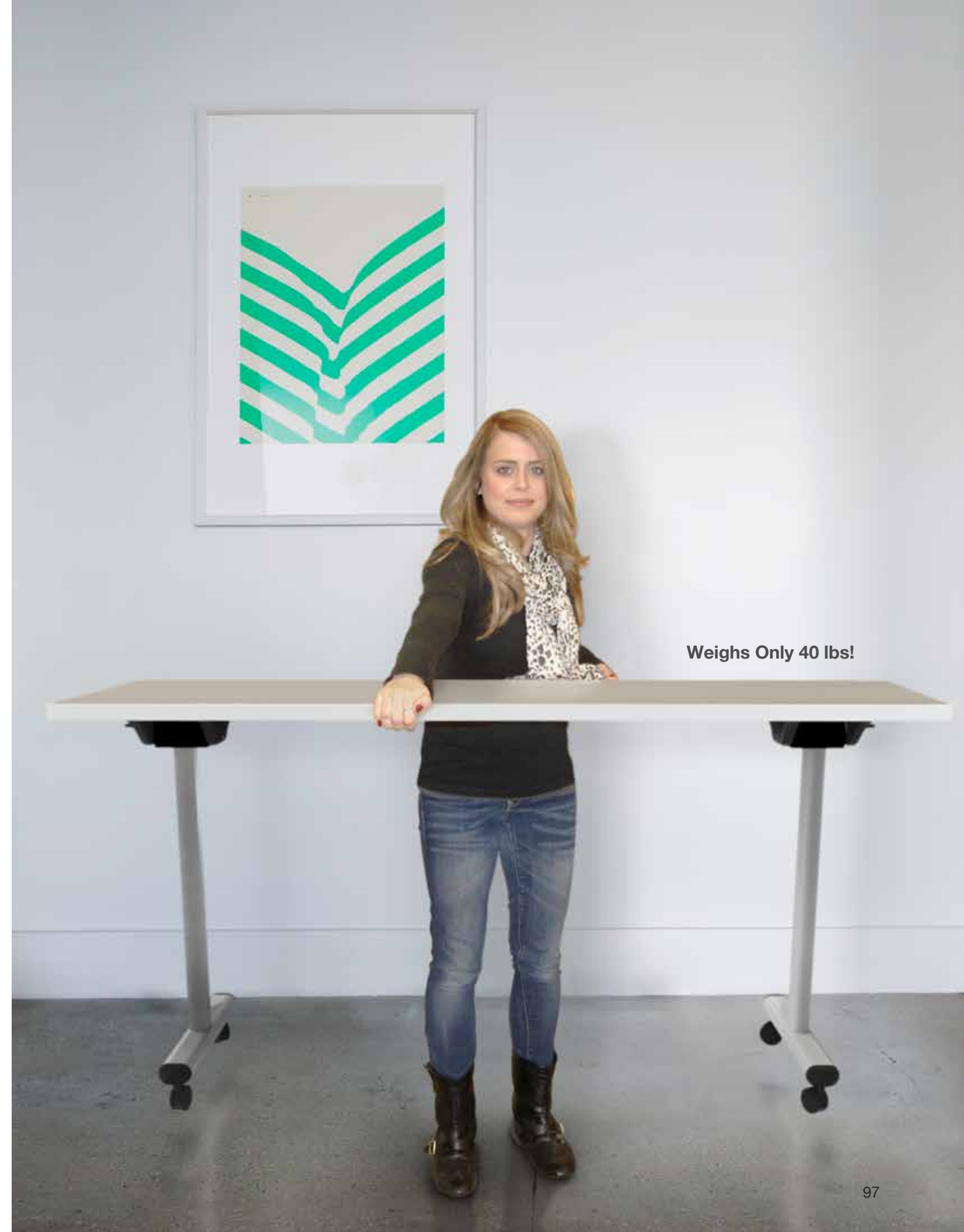

Weights Only 40 lbs!

Greenlites™ Lightweight Tables

How do we make them so light?

By swapping our usual green particle board table top substrate with an ultra light honeycomb material and by trading our typical steel bases for aluminum ones, we have managed to take up to half the weight out of our tables. The honeycomb core is made from recycled kraft paper and is bordered with a green MDF made from recycled wood fiber. The aluminum bases are durable, recyclable, and freight-friendly due to their light weight. We cover the substrate with Wilsonart® standard laminate and Wilsonart® matching edgeband.



What's the advantage to a lighter table?

Mobility! Many times it is a requirement that a table needs to flip, fold, nest, stack, or roll. These modular tables are simply easier to move around when they weigh less. Greenlites are the ultimate back saver!

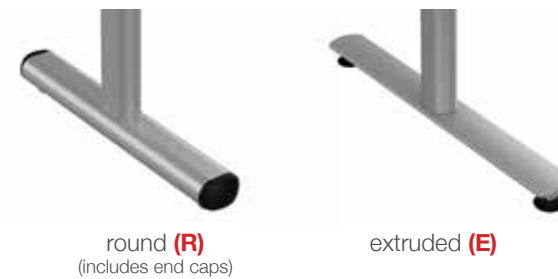

round (R)
(includes end caps)

extruded (E)

	Size	Table Weight (lbs.)	List Price
 Rectangular Flip-Top Nesting (N)*	20"x60" (2460)	40	\$1,556
	20"x72" (2472)	43	\$1,636
	24"x60" (2460)	43	\$1,604
	24"x72" (2472)	48	\$1,692
	30"x60" (3060)	49	\$1,784
 Rectangular Folding (F)**	30"x72" (3072)	52	\$1,892
	20"x60" (2460)	40	\$1,380
	20"x72" (2472)	43	\$1,460
	24"x60" (2460)	43	\$1,424
	24"x72" (2472)	48	\$1,512
	30"x60" (3060)	49	\$1,608
	30"x72" (3072)	52	\$1,716

Wilsonart Laminate Design Sampling (3 mm edgeband to match Wilsonart standard colors and designs.)



Please Note: Baltix standard Wilsonart laminate finishes are 38 or 60. Non-standard Wilsonart finishes require an upcharge. Hundreds of additional laminate colors and designs are available. Baltix also works with laminates from Formica, Nevimar, and Pionite.

Aluminum Base Color Selection (powder coat)

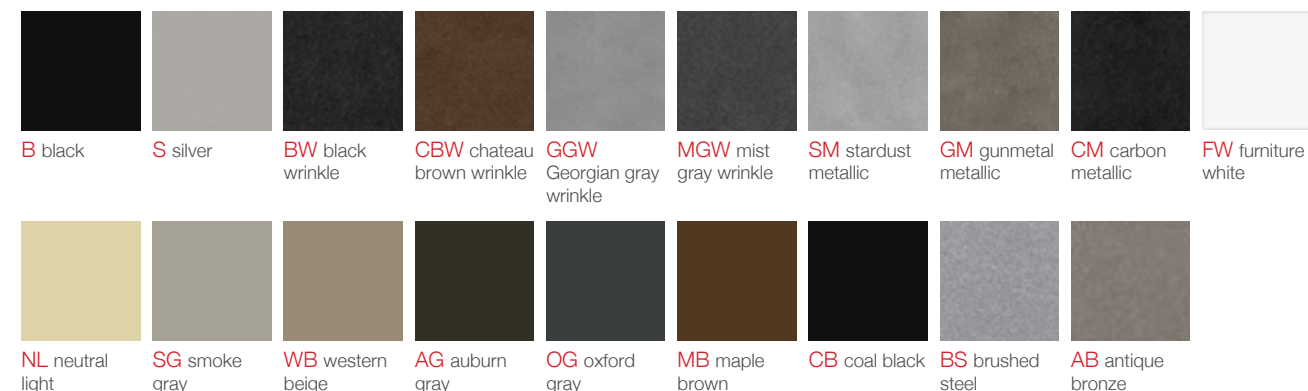

Edge Profile

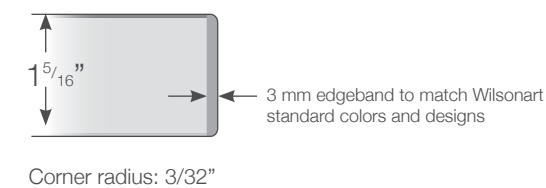

Part # Assessment

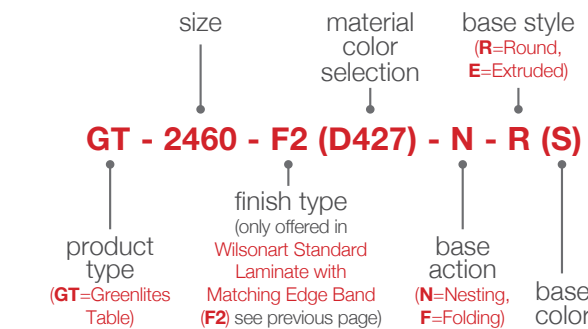

Please Note:

- * Nesting tables come standard with 2" premium locking casters.
- ** Folding tables come standard with levelers. 2" premium locking casters can be substituted for an upcharge of \$100 list per table.



Adjustable Height Tables



Adjustable Height Tables

Range of height varies depending on mechanism used. See next page for information on the four mechanisms available and their height ranges.

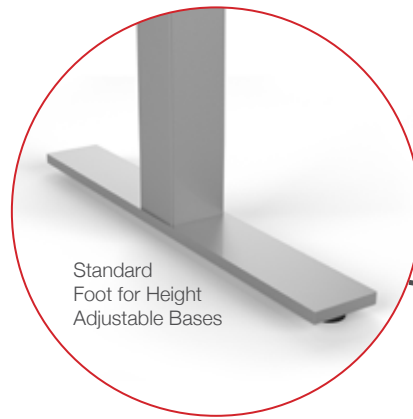
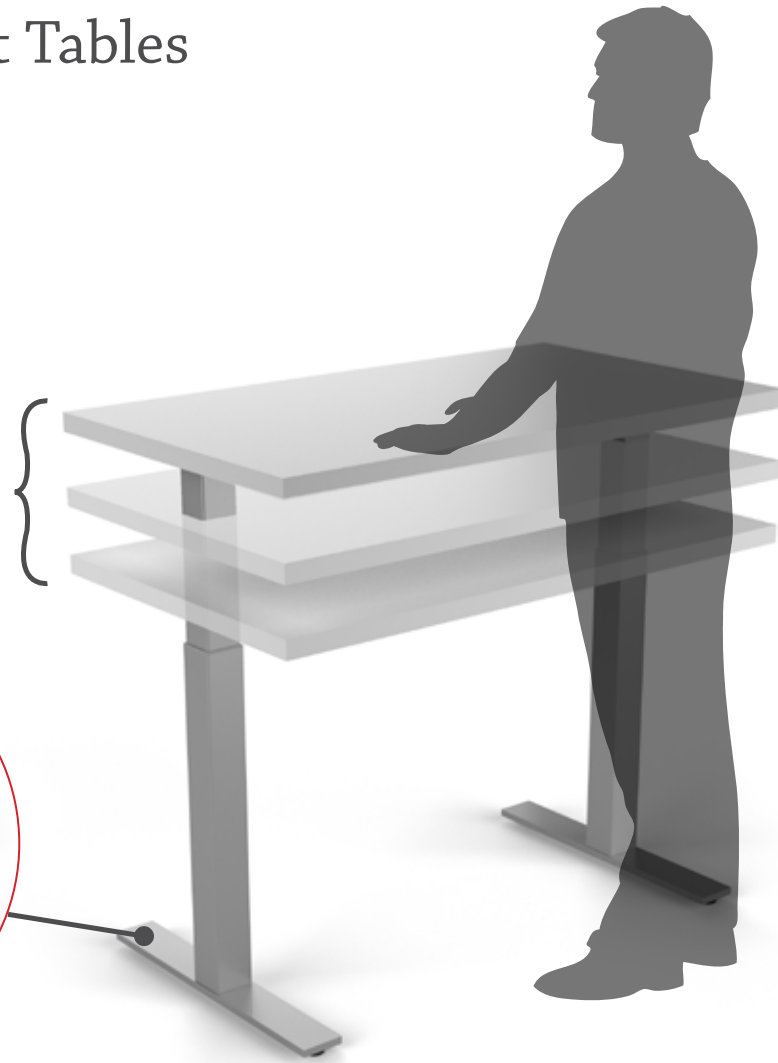

Standard Foot for Height Adjustable Bases

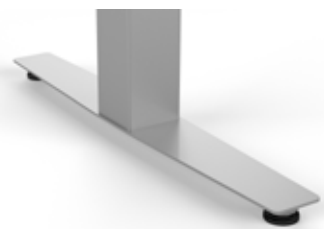

Premium Foot for Height Adjustable Bases +P

To replace standard FootAdd \$170 per table

Part # Assessment

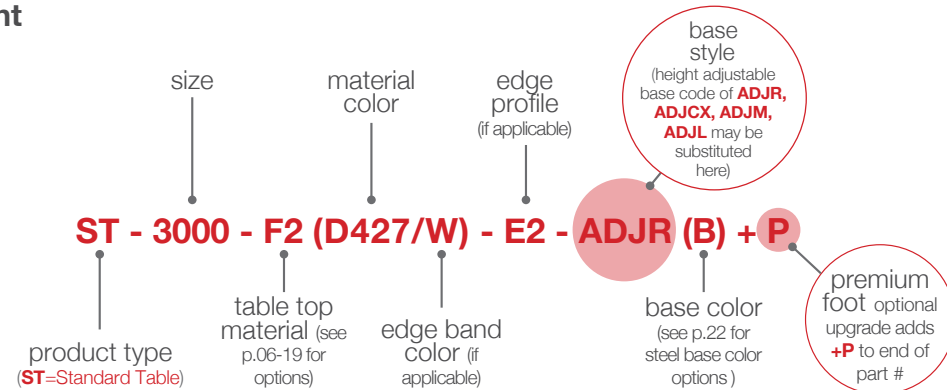

Size	Table Top Finish and Edge Type						
	F2	F4	F6	F7	F8	F17	
30" Ø (3000)	\$724	\$779	\$760	\$818	\$724	\$978	
36" Ø (3600)	\$973	\$1122	\$937	\$1145	\$866	\$1204	
24"x24" (2424)	\$623	\$672	\$633	\$701	\$659	\$799	
30"x30" (3030)	\$732	\$791	\$765	\$830	\$736	\$989	
24"x60" (2460)	\$1115	\$1190	\$1261	\$1209	\$1089	\$1437	
24"x72" (2472)	\$1177	\$1356	\$1174	\$1417	\$1154	\$1586	
30"x60" (3060)	\$1214	\$1289	\$1253	\$1347	\$1117	\$1669	
30"x72" (3072)	\$1278	\$1746	\$1350	\$1922	\$1307	\$1892	
24"x60" (2460)	\$1329	\$1404	\$1475	\$1423	\$1303	\$1651	
24"x72" (2472)	\$1391	\$1569	\$1387	\$1631	\$1368	\$1800	
30"x60" (3060)	\$1428	\$1503	\$1467	\$1561	\$1330	\$1883	
30"x72" (3072)	\$1492	\$1960	\$1563	\$2135	\$1521	\$2106	
24"x60" (2460)	\$2012	\$2087	\$2159	\$2107	\$1986	\$2334	
24"x72" (2472)	\$2074	\$2253	\$2071	\$2315	\$2051	\$2484	
30"x60" (3060)	\$2111	\$2186	\$2150	\$2245	\$2014	\$2566	
30"x72" (3072)	\$2176	\$2644	\$2247	\$2819	\$2205	\$2790	
24"x60" (2460)	\$2106	\$2181	\$2252	\$2200	\$2080	\$2428	
24"x72" (2472)	\$2190	\$2369	\$2187	\$2431	\$2167	\$2600	
30"x60" (3060)	\$2208	\$2282	\$2247	\$2341	\$2110	\$2663	
30"x72" (3072)	\$2266	\$2734	\$2338	\$2910	\$2295	\$2880	

Ratchet (manual) (ADJR)
Simply grab the edge of the table top and lift to raise. The ratchet mechanism will click incrementally until it reaches the highest position...then it will lower all the way back down, similar to a reclining lawn chair.
Base height: 26" to 35.5" (9.5" range)

Crank (manual) (ADJCX)
Height adjustability at the turn of a handle. Handle pulls out to adjust height and then pushes back under table, out of sight.
Base height: 26" to 43.5" (17.5" range)

Motor (electric) (ADJM)
Adjust your table height at the push of a button. Motor gives the largest height range. Because it's electric...you guessed it...it will need to be plugged in.
Base height: 26" to 45.7" (19.7" range)

Pneumatic Lift (manual) (ADJL)
Smooth adjustability with an easy lever release. On the pneumatic lift, the leg is inverted, meaning the "inner column" will grow out of the bottom of the leg, near the foot.
Base height: 26" to 45.7" (19.7" range)

Note: To achieve the optimal performance for the pneumatic lift, we want to make sure we give your mechanism the right amount of "muscle" to lift the table top and anything on it. When ordering, please contact us to chat about your intended application.



**For power & data options and wire management, see pages 112-115.

Lecterns



Lecterns



Standard Lectern **LECS**

Two shelves, fixed height, 4 outlet electrical power strip base mounted (optional), 2" casters on one side for wheelbarrow-style rolling. Wilsonart front panel available in 18 standard colors (see next page). 20"d x 29"w x 44"h

Standard lectern (example: **LECS-D427**) List Price \$1,710
 Add 4 outlet electrical power strip **+PD** (example: **LECS-D427+PD**)Add \$235 to List Price



Premium Lectern **LECP**

Storage box with locking door, pull out shelf, top mounted power/data sphere, 2" casters on one side for wheelbarrow-style rolling. Wilsonart lectern body available in 18 standard colors (see next page). 24"d x 29"w (with side shelf: 40"w) x 46"h

Premium Lectern (example: **LECP-D427**) List Price \$4,605
 Flip up side shelf **+SS** (example: **LECP-D427+SS**)Add \$192 to List Price

Finish Options

Wilsonart Laminate Design Sampling (edgebanding to match)



Please Note: Baltix standard Wilsonart laminate finishes are 38 or 60. Non-standard Wilsonart finishes require an upcharge.

Steel Frame Color Selection (powder coat)



For table bases that match lecterns, see the Wedge bases on page 38.

Filing & Storage Units

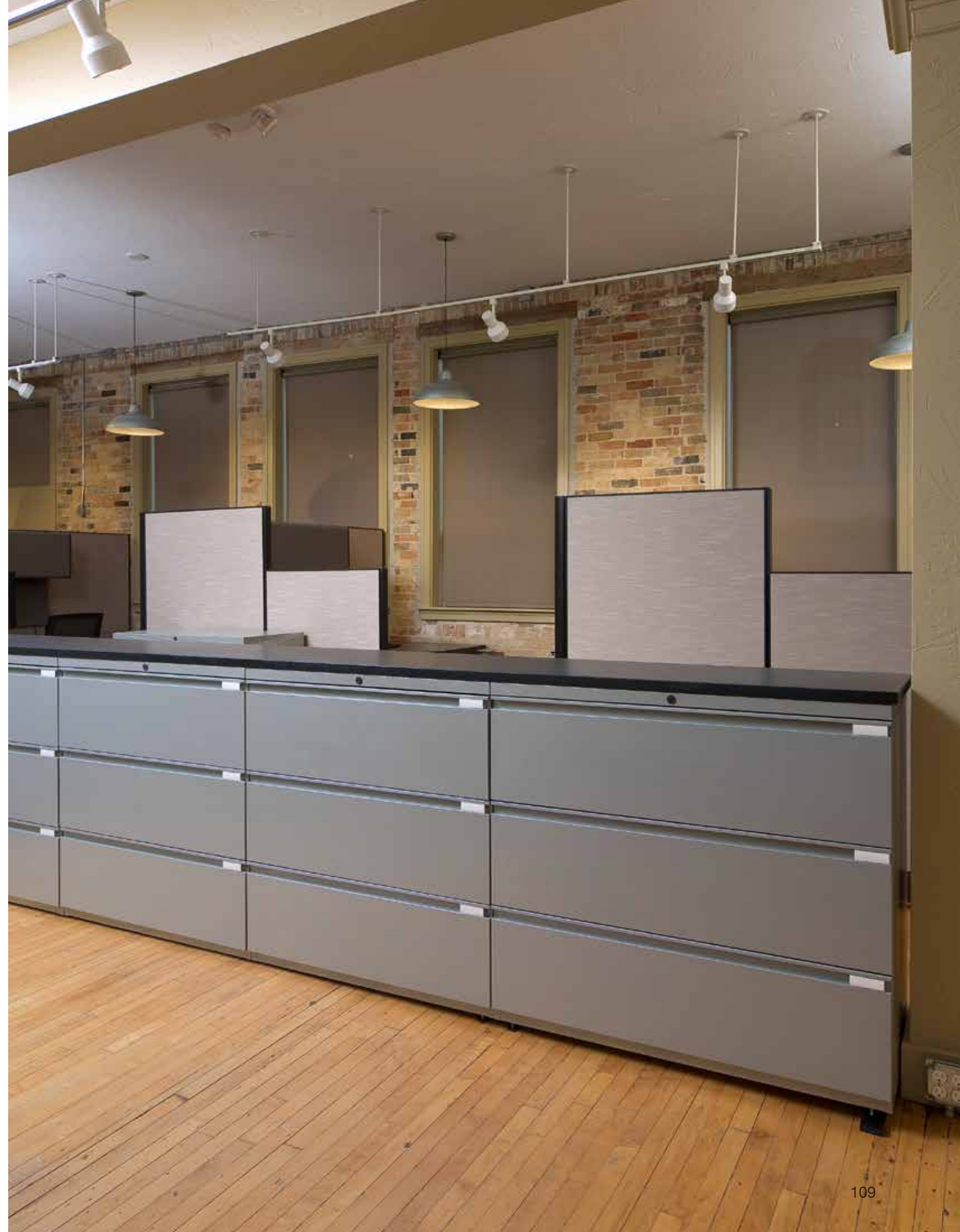

Filing & Storage Units

Drawer Pull Options



Powder Coat Colors

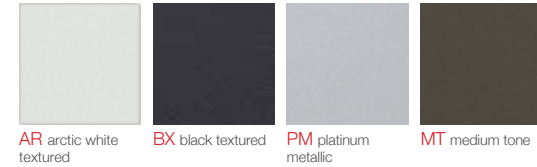

Lock



Part # Assessment

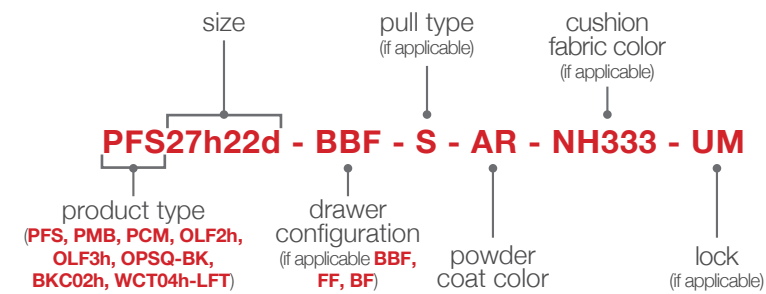

Freestanding Pedestal File (Box/Box/File) **PFS-BBF**

Solid top and counterweight included. 22"d x 15"w x 27-1/2"h
 (example: PFS27h22d-BBF-S-AR-UM)..... \$495 list each



Freestanding Pedestal File (File/File) **PFS-FF**

Solid top and counterweight included. 22"d x 15"w x 27-1/2"h
 (example: PFS27h22d-FF-S-AR-UM)..... \$460 list each



Mobile Pedestal File (Box/Box/File) **PMB-BBF**

Includes 4 black plastic casters - 2 locking, 2 non-locking. Solid top and counterweight included. Fits under most standard-height desks. 15"w x 27-5/16"h
 18" deep (example: PMB27h18d-BBF-S-AR-UM)..... \$498 list each
 22" deep (example: PMB27h22d-BBF-S-AR-UM)..... \$543 list each



Mobile Pedestal File (File/File) **PMB-FF**

Includes 4 black plastic casters - 2 locking, 2 non-locking. Solid top and counterweight included. Fits under most standard-height desks. 15"w x 27-5/16"h
 18" deep (example: PMB27h18d-FF-S-AR-UM)..... \$465 list each
 22" deep (example: PMB27h22d-FF-S-AR-UM)..... \$480 list each



Cushion Top Mobile Pedestal File (Box/File) **PCM-BF**

Includes 4 black plastic casters - 2 locking, 2 non-locking. Counterweight included. 15"w x 24-1/8"h
 18" deep (example: PCM24h18d-BF-S-AR-NH333-UM)..... \$495 list each
 22" deep (example: PCM24h22d-BF-S-AR-NH333-UM)..... \$596 list each

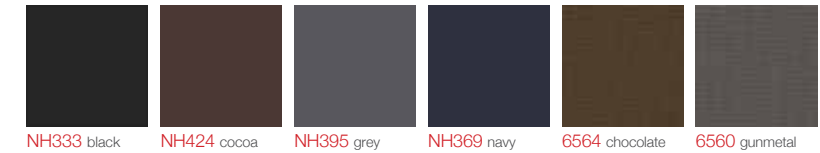

2-High Lateral File **OLF02h**

Safety interlock system allows only one drawer to be opened at a time. 18"d x 36"w x 27-1/2"h
 (example: OLF02h36w-S-AR-UM)..... \$735 list each



3-High Lateral File **OLF03h**

Safety interlock system allows only one drawer to be opened at a time. List pricing includes counter weight to prevent tipping. 18"d x 36"w x 39-1/2"h
 (example: OLF03h36w-S-AR-UM)..... \$994 list each



2 Shelf Bookcase with Square Legs **OPSQ-BK**

Includes four square legs (shipped detached). One height-adjustable shelf. 17-1/8"d x 30"w x 23"h
 (example: OPSQ-BK30w-AR)..... \$610 list each



2 Shelf Bookcase with Levelers **BKC02h**

Includes leveling glides with 3/4" adjustability. One height-adjustable shelf. 14"d x 30"w x 27 1/2"h
 (example: BKC02h30w-AR)..... \$575 list each



4-High Wardrobe-Cupboard Tower **WCT04h-LFT-FF**

Includes 3 locks (keyed alike), coat closet wardrobe (left side), one adjustable cupboard shelf, and file/file pedestal. List pricing includes counter weight to prevent tipping. 24"d x 24"w x 51-1/2"h
 (example: WCT04h-LFT-FF-S-AR-UM)..... \$1,650 list each

Optional Power/Data Unit Add-ons



+M2X

Sits flat within the work surface for a high end finish, simply press on either side and it will pop up for use. Contains recycled content that can contribute toward LEED points.
 Configuration Options: • 2 Power/2 USB • 2 Power/2 Open Data (shown) • 4 Power
 Cord Lengths: • 72" (3-Prong) • 120" (3-Prong)
 Color Options: • Black Anodized Aluminum • Silver Anodized Aluminum (shown) \$1,051 list each



+E2X

With two power outlets and two single data ports on each side*. Sits flat within the work surface for a high end finish. Lift lid for access; lid can be closed while cords are plugged in for a flush top.
 Configuration Options: • 3 Power/3 Open Data (shown) • 2 Power/2 Open Data • 3 Power/1 Extron Adapter
 Cord Lengths: • 72" (3-Prong) • 120" (3-Prong)
 Color Options: • Black Anodized Aluminum • Silver Anodized Aluminum (shown) \$678 list each



+Ellora

This simple, smart design keeps cable clutter out of sight by allowing use while the lid is shut.
 Configuration Options: • 2 Power/1 USB/1 Cat 6 (shown) • 2 Power/2 Open Data • 3 Power/1 Extron Adapter
 Cord Lengths: • 72" (3-Prong) • 120" (3-Prong)
 Color Options: • Black Anodized Aluminum (shown) • Silver Anodized Aluminum \$441 list each



+ElloraQi

Here, users can walk up and connect - whether they're plugging in a laptop, iPhone, or tablet. Or maybe they're not plugging in at all - using Qi compatible charging on the lid instead.
 Configuration Options: • 2 Power/2 USB/3 Qi Coils • 3 Power/1 USB/3 Qi Coils (shown)
 Cord Lengths: • 72" (3-Prong) • 120" (3-Prong)
 Color Options: • Matte Black • Matte White (shown) \$694 list each



+Nacre

Stylish Nacre pops up to reveal a dynamic range of power, data and USB configurations.
 Configuration Options: • 2 Power/2 USB • 3 Power/1 USB (shown) • 4 Power
 Cord Lengths: • 72" (3-Prong) • 120" (3-Prong)
 Color Options: • Black • White (shown) \$335 list each



+Nacre2Port

All the style of Nacre in a compact, two port size.
 Configuration Options: • 1 Power/1 USB (shown) • 1 Power/1 USB A+C • 2 Power
 Cord Lengths: • 72" (3-Prong) • 120" (3-Prong)
 Color Options: • Black • White (shown) \$234 list each



+DEAN

Low profile and smooth, easy-to-clean surface doesn't pull attention away from other workplace elements.
 Configuration Options: • 2 Power/1 USB (shown) • 2 Power • 3 Power
 Cord Lengths: • 72" (3-Prong) • 120" (3-Prong)
 Color Options: • Black (shown) • White \$257 list each



+GARCIA

Low-profile, low-voltage Garcia mounts under your surface.
 Configuration Options: • 2 USB (shown)
 Cord Lengths: • 60" Power Supply Cord
 Color Options: • Black (shown) • White \$155 list each



+MINI

Two outlets that can be mounted near the edge of the worksurface without cutting into it.
 Configuration Options: • 2 USB (shown)
 Cord Lengths: • 60" Power Supply Cord
 Color Options: • Black (shown) • White \$167 list each



+HQ

All of your technology can come together to recharge—however you connect. There's USB access, power, even wireless—simply set any Qi-friendly device on the surface.
 Configuration Options: • 1 Power/1 USB/1 Charging Pad (shown)
 Cord Lengths: • 72" (3-Prong) • 120" (3-Prong)
 Color Options: • Black (shown) • White \$241 list each



+HQ2

All the convenience of the HQ with an extra USB and two charging pads to power even more gadgets.
 Configuration Options: • 1 Power/2 USB/2 Charging Pads (shown)
 Cord Lengths: • 72" (3-Prong) • 120" (3-Prong)
 Color Options: • Black • White (shown) \$439 list each



+HEMISPHERE

The domed shape, soft touch finish, and circular simplex trio is modern yet playful.
 Configuration Options: • 2 Power/1 USB • 2 Power/1 USB A+C (shown) • 3 Power
 Cord Lengths: • 72" (3-Prong) • 120" (3-Prong)
 Color Options: • Black • White (shown) \$203 list each



+ECLIPSE

First you see its modern circular simplex design—then the face cleverly rotates to hide away when not in use.
 Configuration Options: • 2 Power/1 USB • 3 Power (shown)
 Cord Lengths: • 72" (3-Prong) • 120" (3-Prong)
 Color Options: • Black (shown) • White \$263 list each



+NODE

The easy elegance of Node's clean, flush mount design is sure to complement a wide range of aesthetics.
 Configuration Options: • 1 USB (shown) • 1 Power/1 USB A+C • 2 Power
 Cord Lengths: • 72" (3-Prong) • 120" (3-Prong)
 Color Options: • Black • White (shown) \$207 list each



+RSALT

Salt is a charging dynamo with dual charging USB.
 Configuration Options: • 1 USB
 Cord Lengths: • 72" (3-Prong) • 120" (3-Prong)
 Color Options: • Black • White (shown) \$98 list each



+RPEPPER

Pepper is all power with it's single spill-proof simplex.
 Configuration Options: • 1 Power
 Cord Lengths: • 72" (3-Prong) • 120" (3-Prong)
 Color Options: • Black (shown) • White \$58 list each



+SSALT

Salt is a charging dynamo with dual charging USB.
 Configuration Options: • 1 USB
 Cord Lengths: • 72" (3-Prong) • 120" (3-Prong)
 Color Options: • Black (shown) • White \$98 list each



+SPEPPER

Pepper is all power with it's single spill-proof simplex.
 Configuration Options: • 1 Power
 Cord Lengths: • 72" (3-Prong) • 120" (3-Prong)
 Color Options: • Black • White (shown) \$58 list each

Optional Wire Management Add-ons



Wireway Grommet **+WG**

Grommet cutout with insert and cover. Hole size= 2", Overall diameter= 2 3/8"
 Color Options: • Black (shown) • White • Gray..... \$50 list each



4 Loop Wire Manager **+WM**

Screws to underside of the table surface. Just slip wires through the loops! 2 19/32"d x 3 5/8"w x 1 5/8"h
 Black only \$24 list each



Snap-on Wire Manager **+WMS**

Easy snap-on installation allows cover to be repositioned repeatedly. Capacity for many sizes of power and data cables. Standard length= 17 3/4"
 Color Options: • any steel base color (pg.22) except brushed steel and antique bronze \$40 list each



Magnetic Wire Manager Cover for Square Column Bases **+MWM**

Large area for wire management of multiple power and cord sizes. Easy installation and reposition to any metal surface. 1"d x 2"w x 17 3/4"l
 Color Options: • any steel base color (pg.22) except wrinkle, metallic, brushed steel, or antique bronze \$45 list each



Oval Wire Management Holes **+WMO**

Two simple oval holes on the inside of table leg to feed most cords/plugs down leg column. 1" x 2 1/2"
 Add-on price..... \$24 list each



Hinged Wire Management Door **+WMHD**

Hinge allows you to easily push open and feed your cords through. Door blends into the base to give it a solid look. Hole diameter=1" Hinged door= 3/4"w
 Color Options: • any steel base color (pg.22) except brushed steel and antique bronze \$100 list each



Bolt-On Wire Management Door **+WMBD**

Available on 18" and 24" drum bases. Door size for 18"=19" x 6 5/8" Door size for 24"=19" x 8 5/8"
 2 Holes= 3" diameter
 Color Options: • any steel base color (pg.22) except brushed steel and antique bronze \$300 list each



Wire Management Power Box **+WMPB**

Allows for almost any power/data option to be located in the center of a round or square table. Power box dimensions=12"d x 12"w x 3"h Power box hole dimensions=2" diameter on 3" column, 3 1/2" diameter on 4" column Bottom hole dimensions=1 1/2" diameter on 3" column, 2" diameter on 4" column
 Add-on price..... \$50 list each

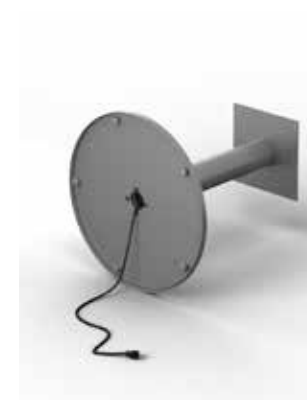

Wire Management for Disk Bases **+WMFD**

Thru-holes from mounting plate to floor. Allows for wires to pass from simple grommet hole or single low profile power or data unit located in the center of a round or square table down through the column and out the bottom of the disk base. Bottom hole dimensions=1 7/8" diameter hole on bottom of 3" column, 2 1/4" diameter hole on bottom of 4" column
 Add-on price..... \$45 list each

Table Top Only (TT)

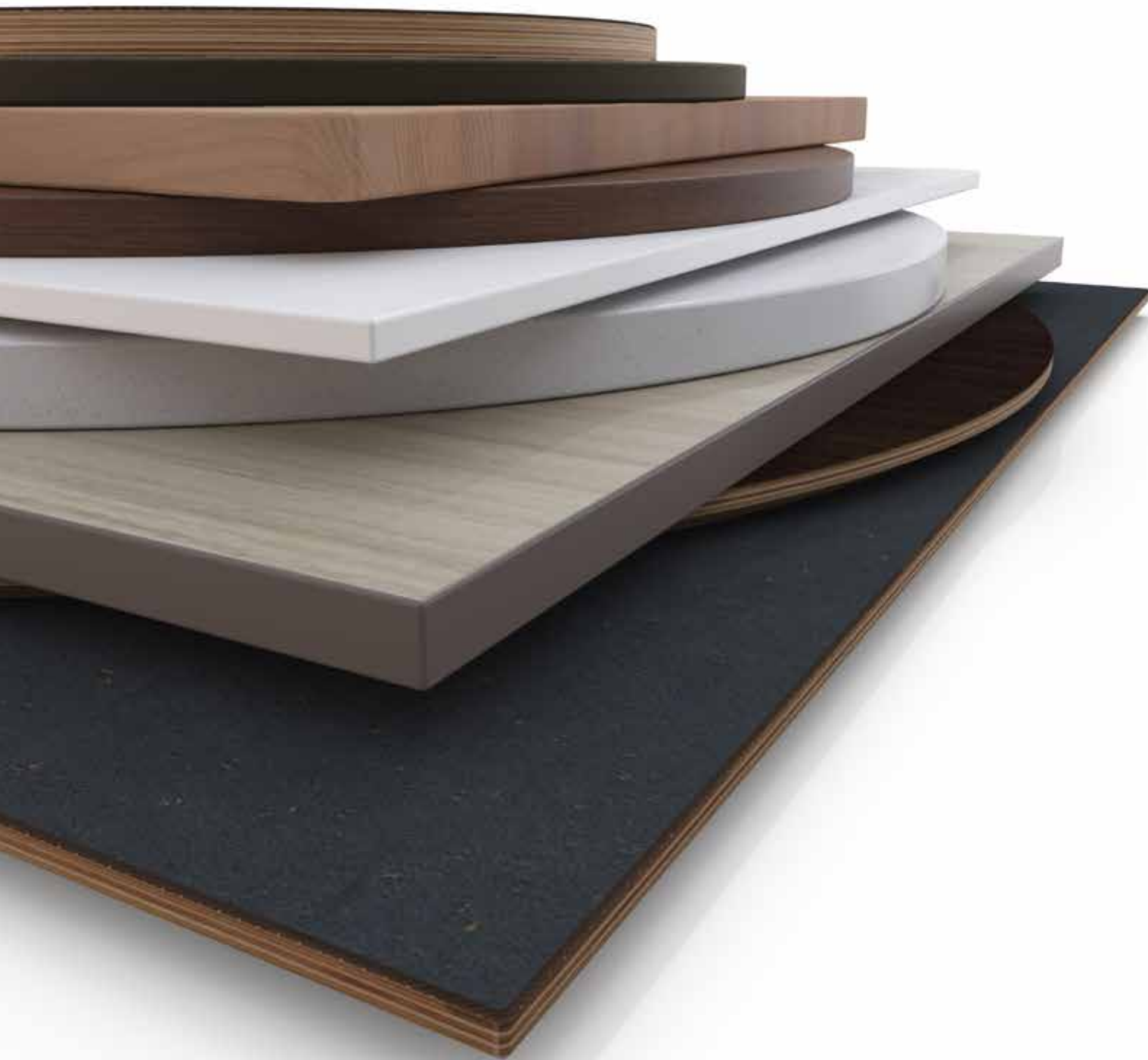

	Size	Table Top Finish and Edge Type					
		F2 Wilsonart® Standard Laminate with Matching Edge Band (p.06)	F4 Wilsonart® Standard Laminate with MultiPLY (p.07)	F6 Forbo® Linoleum on Birch Edgeband (p.07)	F7 Forbo® Linoleum with BioEdge™ MultiPLY (p.08)	F8 Powder Coated MDF (p.09)	F17 Solid Hardwood (Butcher Block) (p.10)
	24" Ø (2400)	\$184	\$240	\$199	\$274	\$225	\$386
	30" Ø (3000)	\$300	\$364	\$341	\$409	\$300	\$593
	36" Ø (3600)	\$574	\$746	\$533	\$773	\$450	\$840
	42" Ø (4200)	\$630	\$840	\$754	\$1,035	\$544	\$1,099
	48" Ø (4800)	\$690	\$953	\$859	\$1,193	\$600	\$1,470
	60" Ø (6000)	\$1,133	\$1,481	\$1,294	\$1,620	N/A	\$2,273
	24"x24" (2424)	\$184	\$240	\$195	\$274	\$225	\$386
	30"x30" (3030)	\$296	\$364	\$334	\$409	\$300	\$593
	36"x36" (3636)	\$570	\$746	\$525	\$773	\$450	\$840
	42"x42" (4242)	\$623	\$840	\$750	\$1,035	\$544	\$1,099
	48"x48" (4848)	\$683	\$953	\$848	\$1,193	\$600	\$1,470
	24"x30" (2430)	\$233	\$308	\$248	\$349	\$281	\$480
	30"x36" (3036)	\$420	\$521	\$431	\$574	\$413	\$683
	24"x48" (2448)	\$353	\$476	\$379	\$544	\$394	\$746
	24"x60" (2460)	\$555	\$641	\$724	\$664	\$525	\$926
	24"x72" (2472)	\$626	\$833	\$623	\$904	\$600	\$1,099
	30"x48" (3048)	\$469	\$619	\$499	\$694	\$469	\$956
	30"x60" (3060)	\$656	\$743	\$701	\$810	\$544	\$1,181
	30"x72" (3072)	\$698	\$1,238	\$780	\$1,140	\$731	\$1,406

Part # Assessment

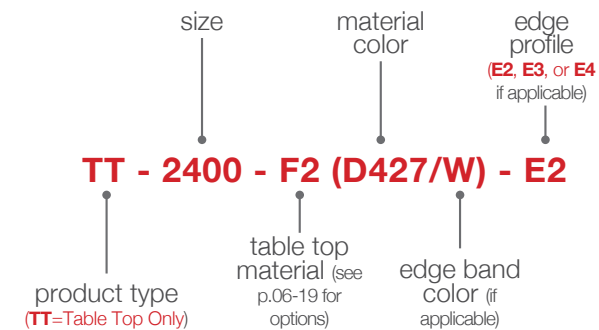

If you don't see the size or shape you need, please contact us for a custom quote.

Terms & Conditions of Sale

General

All prices are shown as list (MSRP). Contact us at info@baltix.com or your preferred dealer for approved discount. All catalogs, photographs, drawings, product price list and other printed materials are protected by copyright. All rights reserved. Product line names are trademarked. All Baltix products are sold using standard terms and conditions of sale found in the product price list, quotes, acknowledgments, and invoices. All submitted orders are subject to acceptance by Baltix. Any modification or supplementation to the terms and conditions must be clearly identified in a separate written document signed by an authorized Baltix representative.

All illustration, specifications, products, and prices in the product price list are based on the latest information available and Baltix reserves the right to make changes at any time without notice. Unauthorized distribution of the product price list does not constitute an offer to sell.

Small Order Processing Fee

Orders with a combined NET price, excluding shipping, under \$1,000.00 will be subject to a Small Order Processing Fee of \$150.00 NET. One charge per order.

Purchase Orders

Orders may be placed at:
E-mail: sales@baltix.com
Order Support: (952)698-1220

Accepted Payment Methods

Check
ACH Debit (no fee)

Remittance Address:
Baltix Sustainable Furniture, LLC
Attn: Accounting
434 Lake Street, Suite 203
Excelsior, MN 55331

Payment Terms

Standard payment terms are 50% down payment at the time of order and balance due upon receipt of product. Orders are not released to production until the required 50% deposit has been received. An authorized Baltix representative must approve any other payment arrangement. Purchaser agrees that Baltix shall have the right to enforce a finance charge of 2% per month on any invoice outstanding more than NET 30 days. If a collection is necessary, the purchaser shall pay all collections costs including attorney's fees. Any product sold is the property of Baltix until the invoices have been paid in full.

Order Acknowledgement

Orders are accepted, manufactured and invoiced in accordance with Baltix acknowledgements and standard terms and condition of sale as stated herein. It is the purchaser's responsibility to notify Baltix of any discrepancies in the acknowledgement within two (2) days of the acknowledgement date, otherwise Baltix can accept no responsibility for manufacturing errors. Ship dates on the acknowledgement are estimated and actual ship dates may vary due to events beyond the control of Baltix.

Taxes

Orders placed in Minnesota must be accompanied by a State Resale/Exemption Certificate (ST3). Baltix is not responsible for collecting sales tax in any other state. If you are not tax exempt, sales tax must be self-assessed.

Storage Policy

If the purchaser is unable to accept delivery as scheduled at the time of shipment, Baltix may transfer the order to storage. The following storage fees will apply; \$300.00 for the first month and \$150.00 for each additional month thereafter. Orders transferred to storage will be considered delivered for purposes including invoicing and payment.

Changes & Cancellation Policy

Baltix is a contract furniture manufacturer producing high quality, finished products that are built-to-order based on the purchaser's specifications. No finished products are inventoried. Orders may not be cancelled or changed without written consent of Baltix, such consent may be withheld, granted or granted subject to conditions, service charges and/or price changes, in Baltix' sole discretion. The refund of the customer's deposits shall not be granted in any circumstance. In the event that Baltix agrees to such a change or cancellation, and customer agrees to pay such charges, including, but not limited to, storage and shipment costs, costs of producing non-standard orders, costs of purchasing non-standard materials, costs of non-returnable items, cancellation costs imposed by Baltix and its suppliers, and any other costs resulting from the cancellation of this order by customer. Baltix may waive such costs at its sole discretion. Baltix does not accept returns.

Freight & Shipping

All orders will be shipped in compliance with National Motor Freight Classification Code (NMFC). All orders will be shipped F.O.B. Baltix Origin, freight cost prepay and add. Legal responsibility for the product transfers to the buyer upon acceptance by the carrier. All products are shipped based on a dock-to-dock delivery only. Unless otherwise noted, Baltix will use "best way" shipping. Baltix assumes no responsibility for warehousing or demurrage when consignee is unable to accept shipment at the delivery point. Additional expenses incurred by Baltix for any add-on accessorials at the time of delivery will be billed to the customer as "additional handling". Examples of add-on accessorials include, but are not limited to: Inside Delivery, Limited Access, Residential Delivery, Construction Site Delivery, and Re-delivery. Baltix shall not be held liable for delays caused by strikes, catastrophes, wars, riots, or any other cause beyond our control.

Customer Pick Ups (3rd Party)

All products are loaded on carrier trucks free from defects and/or damage. Responsibility of safe delivery and transport of products is assumed by the customers carrier upon loading. Legal responsibility and cost for the product transfers to the buyer upon acceptance by the carrier.

Freight Damage

Legal title to merchandise passes to the buyer upon acceptance by the carrier. It is the customer's responsibility to inspect all skids, crates, a-frames, cartons (boxes), and packages at time of delivery for damages or shortages regardless of condition. Any damages found during inspection must be clearly noted on the proof of delivery (POD) slip. It is the customers responsibility to notify the carrier within three (3) days of any visible or concealed damage that has occurred. All product is thoroughly inspected before it leaves our factory; therefore, it is the buyer's responsibility to seek recourse against the carrier.

Warranty, Limitations, & Disclaimers

Warranty

Baltix warrants that all products it manufactures are, at the date of shipment, guaranteed free from defects in materials and workmanship for two (2) years. This warranty is offered to original customers who have acquired the goods directly from a Baltix authorized dealer or direct from Baltix. Any product that fails to function as intended and is found defective in material or workmanship by Baltix will be repaired or replaced without charge to the purchaser or, at the election of Baltix, a credit will be issued up to the invoice price of the product. This warranty is not applicable where, in the judgement of Baltix, the defect is caused by normal wear and tear, misuse, misapplication, modification, or damage after shipment, including failure to properly maintain the product or similar cause. This warranty is in lieu of all other warranties, express or implied, including warranties of merchantability of fitness for ordinary or particular purpose.

Exceptions

Outdoor tables and bases: One (1) year from date of shipment.

Electrical components: One (1) year from date of shipment.

Third Party specified and supplied products: Supplier Warranty

Finishing: our finishes are designed to be moisture resistant, but, if exposed to standing water for longer than 24 hours, discoloration and disfiguration can occur. This is typical for any finished furniture product.

There are no other warranties except as expressly set forth above, either expressed or implied, including any warranty of merchantability or of fitness for a particular purpose.

Design Rights

The designs shown in Baltix' catalogs and price lists are proprietary to Baltix and Baltix reserves the exclusive right to manufacture them. Any reproduction of these designs infringes Baltix' rights and that infringement will be prosecuted.



abnormally green

baltix

sustainable furniture



Centrally located in Minnesota, the land of 10,000 lakes.



Made in the U.S.A.

